



integration with integrity

User's Manual

Mini-ITX Motherboard 2807750

Version 1.0, July 31, 2007

---

---

## **Copyrights**

This manual is copyrighted and all rights are reserved. It does not allow any non authorization in copied, photocopied, translated or reproduced to any electronic or machine readable form in whole or in part without prior written consent from the manufacturer.

In general, the manufacturer will not be liable for any direct, indirect, special, incidental or consequential damages arising from the use of inability to use the product or documentation, even if advised of the possibility of such damages. The manufacturer keeps the rights in the subject to change the contents of this manual without prior notices in order to improve the function design, performance, quality and reliability. The author assumes no responsibility for any errors or omissions, which may appear in this manual, nor does it make a commitment to update the information contained herein.

## **Trademarks**

Intel is a registered trademark of Intel Corporation.

Award is a registered trademark of Award Software, Inc.

All other trademarks, products and or product's name mentioned herein are mentioned for identification purposes only, and may be trademarks and/or registered trademarks of their respective companies or owners.

---

# Packing List:

Please check the package content before you starting using the board.

## Hardware:

2807750 serial Mini ITX Motherboard x 1

## Cable Kit:

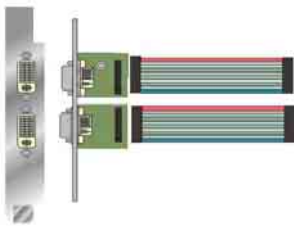
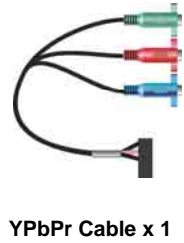
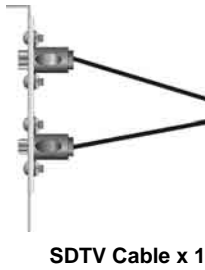
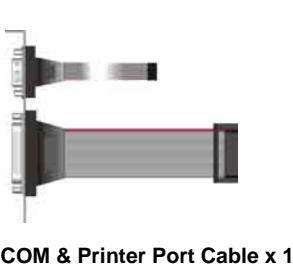
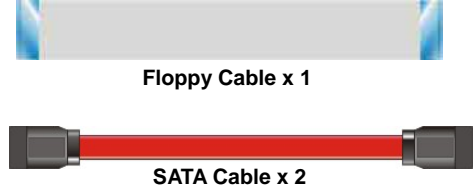
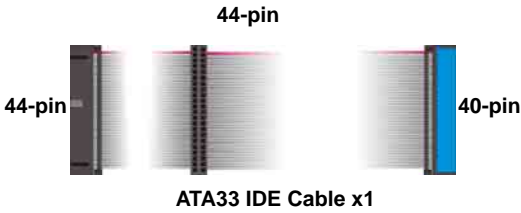

2 DVI module with bracket x 1 (2807750 Serial)

DVI module with bracket x 1 (2807750 Serial)

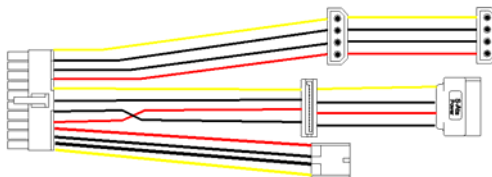

Power Cable

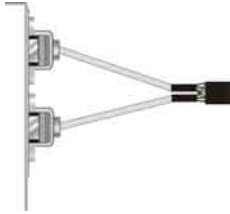

USB Cable x 1



DC Power Cable x 1



CPU Cooler x 1

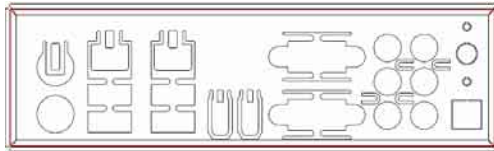

I/O Shield x 1

### Printed Matters:

Driver CD x 1 (Include user's manual ).

## Index

<b>Chapter 1 &lt;Introduction&gt;</b> .....	<b>8</b>
1.1 <Product Overview>.....	8
1.2 <Product Specification> .....	9
1.3 <Mechanical Drawing> .....	11
1.4 <Block Diagram> .....	12
<b>Chapter 2 &lt;Hardware Setup&gt;</b> .....	<b>14</b>
2.1 <Connector Location> .....	14
2.2 <Jumper Location & Reference>.....	15
2.3 <Connector Reference> .....	17
2.3.1 <Internal Connectors>.....	17
2.3.2 <External Connectors>.....	17
2.4 <CPU and Memory Setup> .....	18
2.4.1 <CPU Setup> .....	18
2.4.2 <Memory Setup> .....	19
2.5 <CMOS Setup> .....	20
2.6 <Enhanced IDE Interface> .....	21
2.7 <Serial ATA Interface> .....	22
2.8 <Floppy Port>.....	23
2.9 <Ethernet Interface> .....	24
2.10 <Onboard Display Interface> .....	25
2.10.1 <Analog Display> .....	25
2.10.2 <Digital Display>.....	26
2.10.3 <HDTV Interface>.....	30
2.11 <Integrated Audio Interface>.....	31
2.12 <GPIO Interface> .....	33
2.13 <Power Supply> .....	34
2.13.1 <Power Input> .....	34
2.13.2 <Power Output>.....	36
2.14 <Switch and Indicator>.....	37

---

<b>Chapter 3 &lt;System Setup&gt;</b> .....	<b>38</b>
3.1 <Audio Configuration> .....	38
4. Select the sound mode to meet your speaker system. ....	38
3.2 <Video Memory Setup> .....	39
3.3 <Display Properties Setting>.....	41
<b>Appendix A &lt;I/O Port Pin Assignment&gt;</b> .....	<b>45</b>
A.1 <IDE Port> .....	45
A.2 <Serial ATA Port>.....	46
A.3 <Floppy Port>.....	46
A.4 <IrDA Port>.....	46
A.5 <Serial Port 1>.....	47
A.6 <Serial Port 2>.....	47
A.7 <Parallel Port>.....	47
A.8 <VGA Port>.....	48
A.9 <LAN Port>.....	48
A.10 < USB Interface >.....	48
<b>Appendix C &lt;System Resources&gt;</b> .....	<b>50</b>
<b>Appendix D &lt;Programming GPIO's&gt;</b> .....	<b>54</b>
<b>Appendix E &lt;Programming Watchdog Timer &gt;</b> .....	<b>55</b>
<b>Appendix F &lt;How to setting RS-422 &amp; RS-485&gt;</b> .....	<b>56</b>
<b>Contact Information</b> .....	<b>57</b>

(This page is left for blank)

## Chapter 1 <Introduction>

### 1.1 <Product Overview>

**2807750** is the new generation of the Mini-ITX motherboard, with supporting Intel Core 2 Duo **socket-P** processors for 533/800MHz front side bus, Intel GM(E)965 and ICH8-M chipset, integrated GMA X3100 graphics, DDR2 memory, REALTEK High Definition Audio, Serial ATA and two Intel Gigabit LAN.

#### Intel Merom dual core Processor

The board supports Intel Core 2 Duo **socket-P** processors with 533/800MHz front side bus, 4MB L2 cache, to provide more powerful performance than before.

#### New features for Intel GM(E)965 chipset

The board integrates Intel GM(E)965 and ICH8-M chipset, to provide new generation of the mobile solution, supports Intel GMA X3100 graphics, DDR2 533/667Mhz memory, built-in high speed mass storage interface of serial ATA, High Definition Audio with 7.1 channels surrounding sound.

#### All in One multimedia solution

Based on Intel GM(E)965 and ICH8-M chipset, the board provides high performance onboard graphics, 18/24-bit Single/dual channel LVDS interface, HDTV and 7.1 channels High Definition Audio, to meet the very requirement of the multimedia application.

#### Flexible Extension Interface

The board provides Compact Flash Type II slot , two mini-PCI slot. and one PCI slot.

## 1.2 <Product Specification>

### General Specification

Form Factor	Mini-ITX motherboard
CPU	Support Intel Core 2 Duo Mobile Processor Package type: <b>Micro-FCPGA478 (Socket-P)</b> Front side bus: 533/800 MHz
Memory	Two DDRII 533/667MHz DIMM up to 3GB with dual channel Interleaved mode
Chipset	Intel GM(E)965 & ICH8-M (82801HBM)
Real Time Clock	Chipset integrated RTC with onboard lithium battery
Watchdog Timer	Generates a system reset with internal timer for 1min/s ~ 255min/s
Power Management	ACPI 1.0 compliant, supports power saving mode
PCI Enhanced IDE	One 44-pin UltraATA33 IDE interface supports up to 2 ATAPI devices
Serial ATA Interface	3 x serial ATAII interface with 300MB/s transfer rate
VGA Interface	Intel integrated extreme GMA X3100 (Graphic Media Accelerator) Technology
Video Memory	Up to 384MB shared with system memory
LVDS interface	Onboard 24-bit dual channel LVDS connector with +3.3V/+5V/+12V supply
DVI Interface	Two Chrontel CH7307C DVI transmitter with onboard 26-pin DVI interface
Audio Interface	Intel integrated ICH8-M with Realtek ALC888 HD Audio
LAN Interface	Two Intel 82573L Gigabit LAN
Solid State Disk	IDE supports 44-pin DiskOnModule with +5V/+3.3V power supply, One Compact Flash Type II
GPIO interface	Onboard programmable 8-bit Digital I/O interface
Extended Interface	One PCI slot, Two Mini PCI socket to support Mini PCI Type IIIA
Internal I/O Port	1x RS232/422/485, 1x slim FDD port, 1x GPIO port, 1 x Parallel Port, 4 x USB ports, 1x IrDA, 1x IDE, 1x LVDS, 1x LCD inverter connector, 2 x DVI, 1x HDTV, 1x Front panel Audio connector and 1 x CDIN connector
External I/O Port	1x PS/2 Keyboard/Mouse Port, 2 x RJ45 LAN ports, 1x DB15 VGA port, 4x USB2.0 ports, 2x IEEE 1394 port, 1x RS232 port, 7.1 Channel Audio Output, 1x SPDIF connector
Power Requirement	Standard 20-Pin ATX power supply or 9~24V full range DC Input ( 8~30V operative)
Dimension	170mm x 170mm
Temperature	Operating within 0~60 centigrade Storage within -20~85 centigrade

### Ordering Code

2807750A	Onboard CRT, LVDS, HDTV, Intel Gigabit LAN, USB2.0, PCI, Mini-PCI, GPIO Port, 1394, IrDA, Slim FDD, Parallel Port, RS232/422/485, SATA,HD Audio, <b>1 x DVI</b>
2807750B	Onboard CRT, LVDS, HDTV, Intel Gigabit LAN, USB2.0, PCI, Mini-PCI, GPIO Port, 1394, IrDA, Slim FDD, Parallel Port, RS232/422/485, SATA, HD Audio, <b>2 x DVI and CF</b>

For further product information please visit the website at <http://www.globalamericaninc.com>

## 1.3 &lt;Mechanical Drawing&gt;

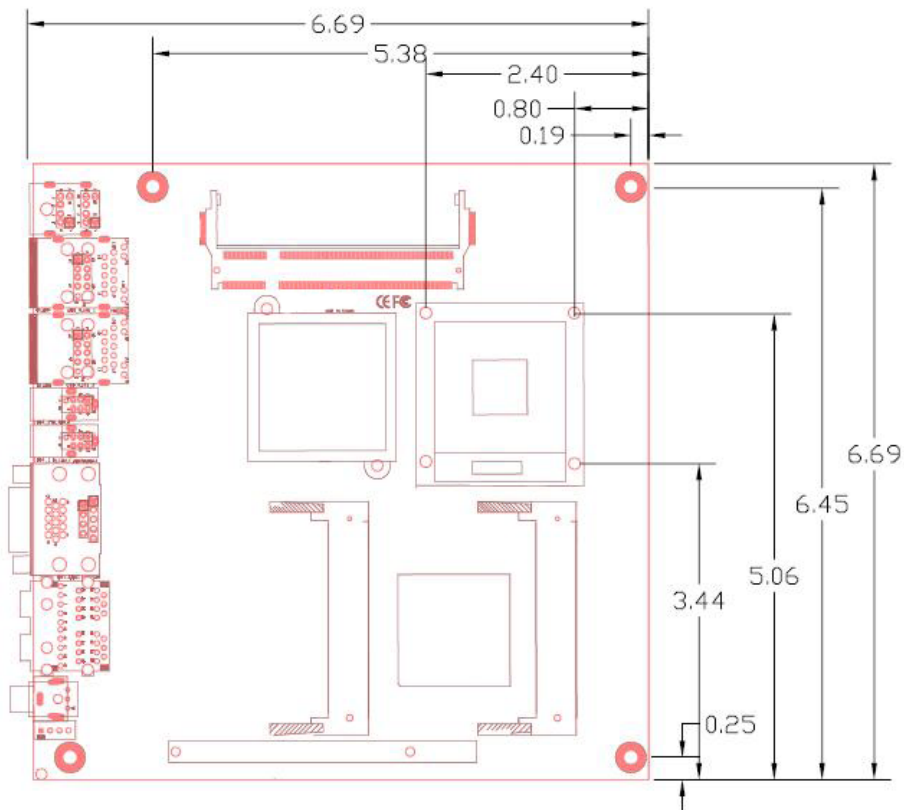

# 1.4 <Block Diagram>

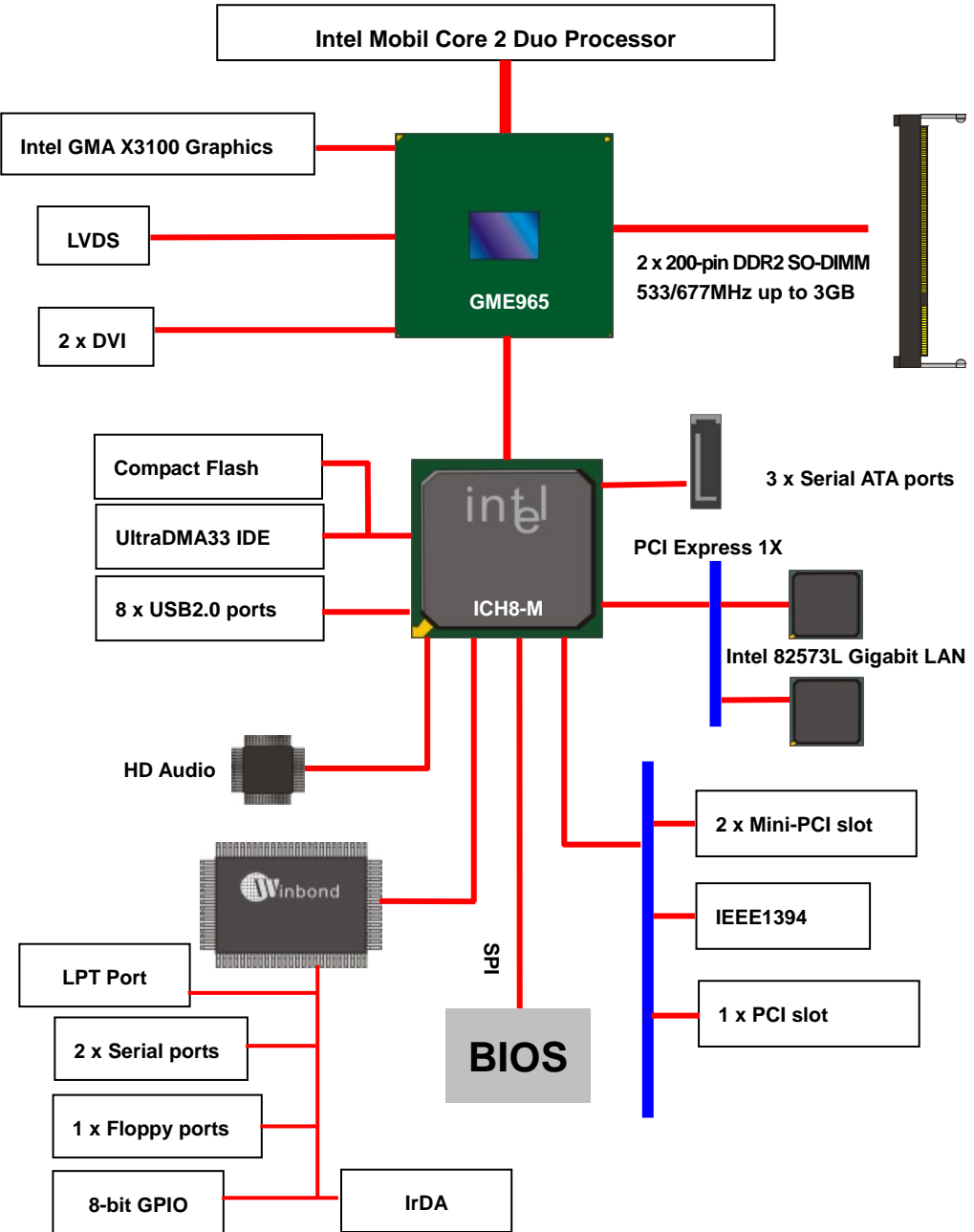

(This page is left for blank)

# Chapter 2 <Hardware Setup>

## 2.1 <Connector Location>

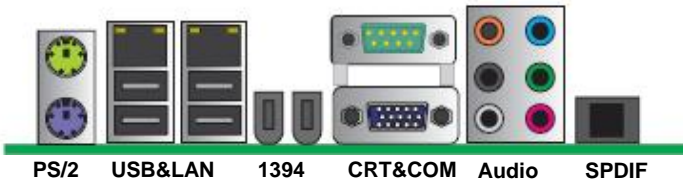
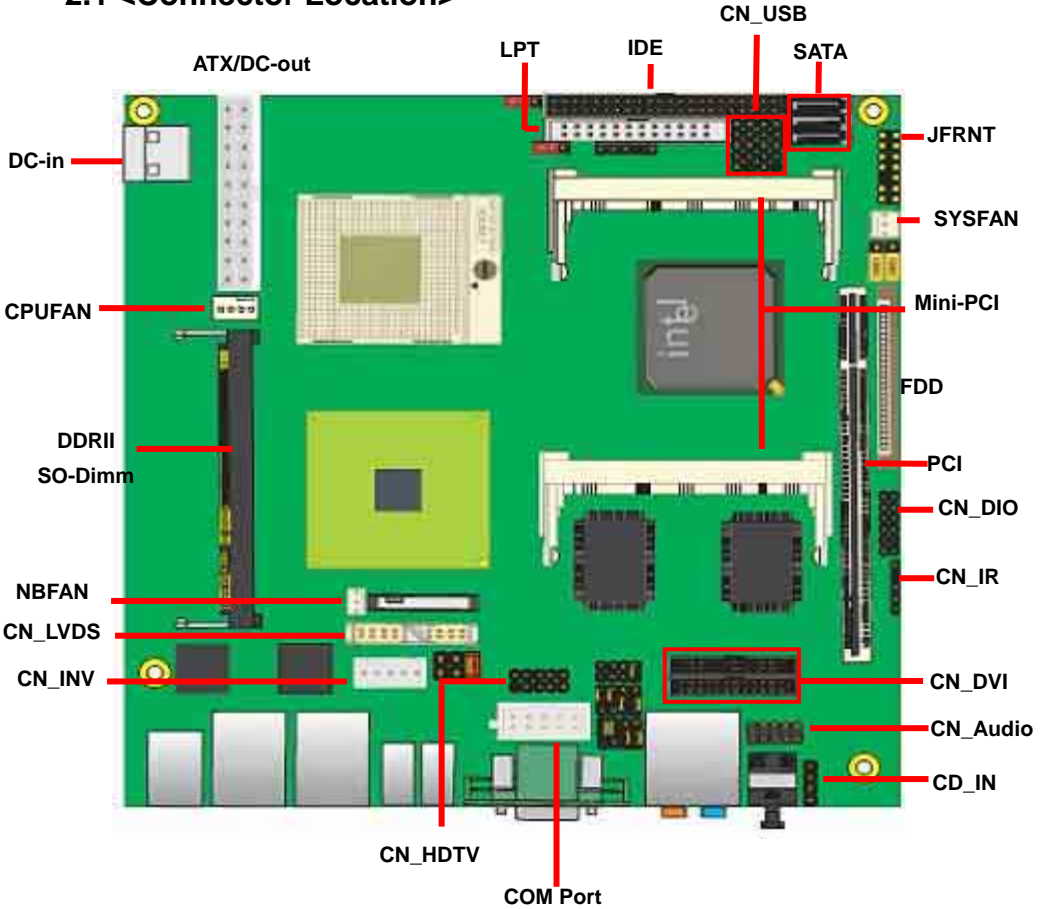

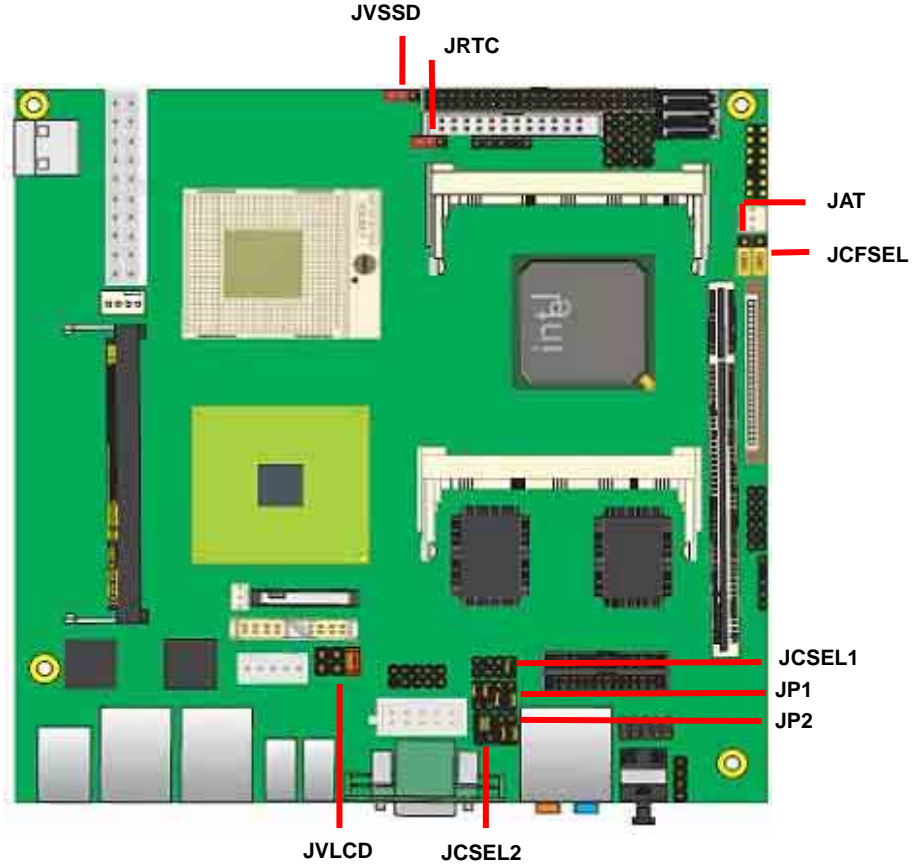

## 2.2 <Jumper Location & Reference>

Jumper	Function
JRTC	CMOS Operating/Clear Setting
JCFSEL	CF with IDE mode selection
JVLCD	Panel Voltage Setting
JVSSD	DOM 3.3V / 5V Power selection
JP1	COM1 signal mode switch (For Pin-1 & Pin-9)
JP2	COM2 signal mode switch (For Pin-1 & Pin-9)
JAT	Power mode select





Jumper: **JAT**

Type: onboard 3-pin header

Power Mode	JAT
AT Mode	
ATX Mode	
Default setting: <b>ATX Mode</b>	
	 1 3



Jumper: **JP1 (COM 1)**

Type: onboard 3 x 2-pin header

Power Mode	JP1
Pin1 with 5V signal	
Pin9 with 12V signal	
Default setting: <b>3-5, 4-6</b>	
	 1 2 5 6

Jumper: **JP2 (COM 2)**

Type: onboard 3 x 2-pin header

Power Mode	JP2
Pin1 with 5V signal	
Pin9 with 12V signal	
Default setting: <b>3-5, 4-6</b>	
	 1 2 5 6

## 2.3 <Connector Reference>

### 2.3.1 <Internal Connectors>

Connector	Function	Remark
CPU	Socket478 for <b>socket-P</b> CPU	
SO-DIMM 1/2	Two 200 -pin DDR2 SO-DIMM slot	
IDE	44-pin IDE connector	
FDD	26-pin slim type floppy connector	
LPT	26-pin LPT port connector	
S_ATA1/2/3	7-pin Serial ATA connector	
DC_IN	9~24V full range DC input (8~30V operative)	DC input Mode
ATX	20-pin power input connector	ATX input Mode
DC-Out	20-pin power output connector	DC Input Mode
CN_AUDIO	5 x 2-pin audio connector	
CDIN	4-pin CD-ROM audio input connector	
CN_DIO	6 x 2-pin digital I/O connector	
CN_USB	Two 5 x 2-pin USB connector	
CPUFAN	4-pin CPU cooler fan connector	
SYSFAN	3-pin system cooler fan connector	
CN_DVI 1/2	13 x 2-pin DVI interface	
CN_HDTV	5 x 2-pin HDTV interface	
CN_LVDS	20 x 2-pin LVDS connector	
CN_INV	5-pin LCD inverter connector	
CN_IR	5-pin IrDA connector	
JFRNT	14-pin front panel switch/indicator connector	
Mini-PCI	2 x Mini-PCI socket Type IIIA	
PCI	32bit PCI slot	
CF	Compact Flash Type II socket	
COM1/2	Serial port connector	
JAT	Power mode select	

### 2.3.2 <External Connectors>

Connector	Function	Remark
USB_RJ45	Dual USB and one RJ45 LAN connector	
CRT + COM1	DB15 analog VGA connector and COM1 Connect	
KB	PS/2 keyboard connector	
MS	PS/2 mouse connector	
AUDIO	Audio connectors	
1394	IEEE1394 port	
SPDIF	SPDIF digital audio output connector	

## 2.4 <CPU and Memory Setup>

### 2.4.1 <CPU Setup>

The board comes with the socket478 for Intel Core 2 Duo **socket-P** processor Only, it supports new generation of Intel Core 2 Duo **socket-P** processor with 533/800MHz of front side bus and 4MB L2 cache. Please follow the instruction to install the CPU properly.

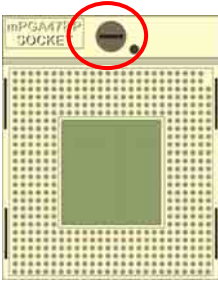

1. Use the flat-type screw drive to unlock the CPU socket

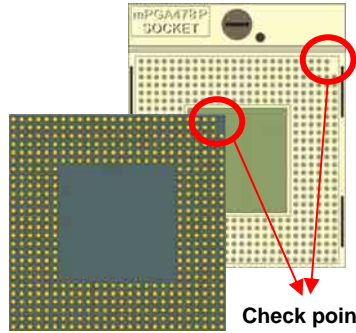

2. Follow the pin direction to install the processor on the socket



3. Lock the socket

4. Socket P has 478 pins, but is not pin-compatible with Socket M CPU.

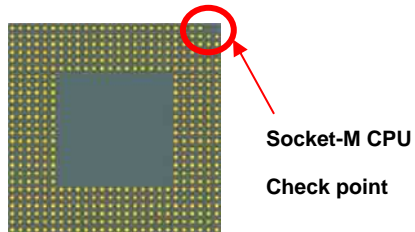

### 2.4.2 <Memory Setup>

The board provides two 200-pin DDR2 SO-DIMMs to support 533/667MHz DDR2 memory modules up to 3GB of capacity. Non-ECC, unbuffered memory is supported only. While applying two same modules, dual channel technology is enabled automatically for higher performance.

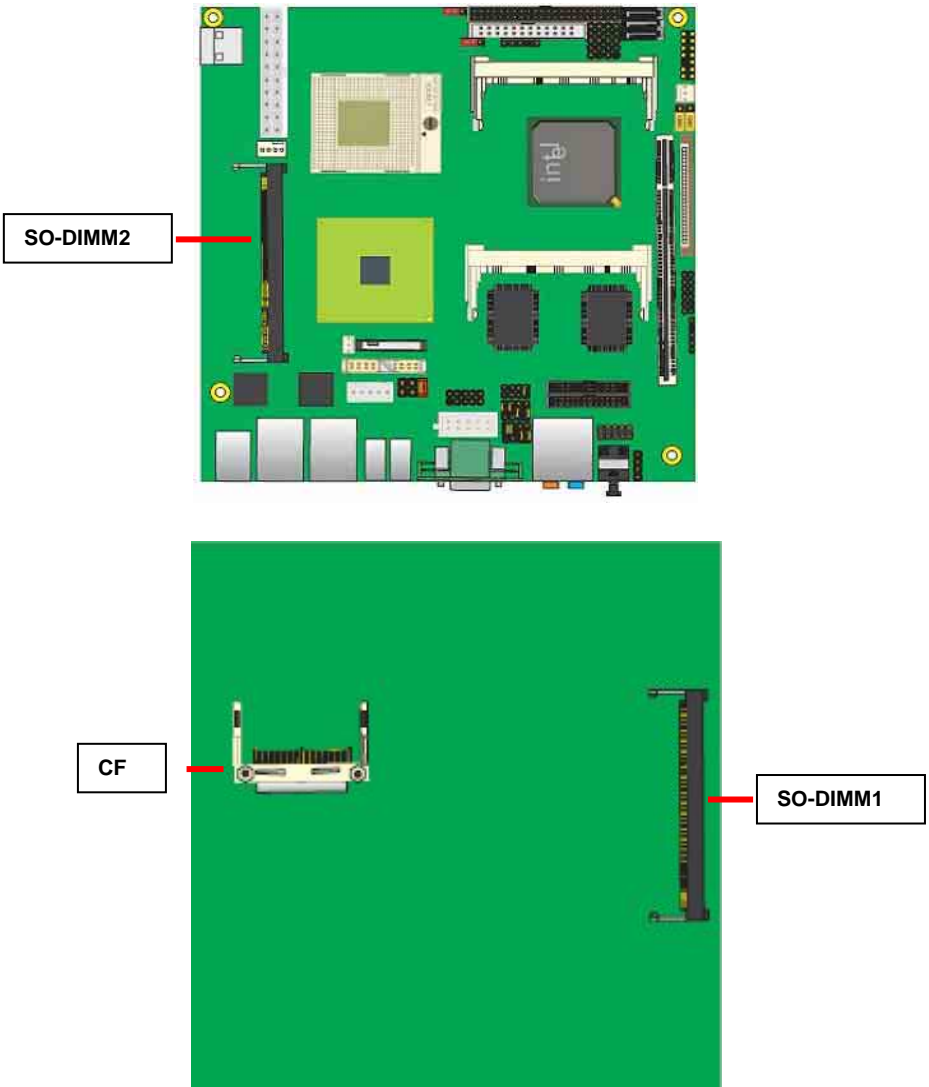

## 2.5 <CMOS Setup>

The board's data of CMOS can be setting in BIOS. If the board refuses to boot due to inappropriate CMOS settings, here is how to proceed to clear (reset) the CMOS to its default values.

**Jumper: JRTC**

**Type: Onboard 3-pin jumper**

JRTC	Mode
1-2	Clear CMOS
2-3	Normal Operation

Default setting: 2-3

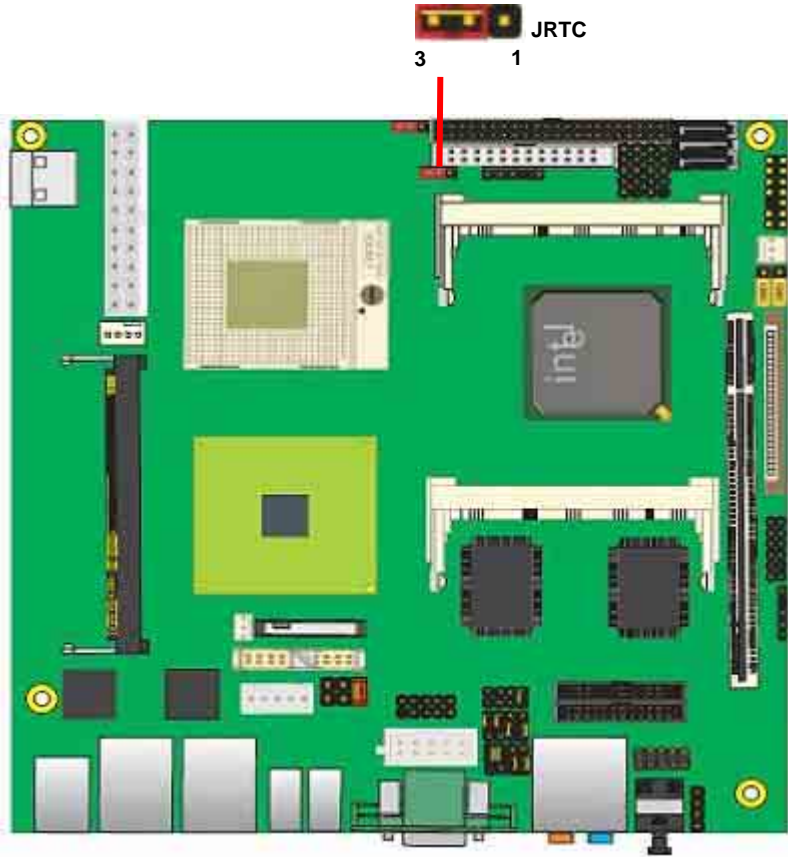

## 2.6 <Enhanced IDE Interface>

The board has one UltraDMA33 IDE interface to support up to 2 ATAPI devices, or one ATAPI device and Compact Flash Type II socket on the solder side, with jumper **JCFSEL** for IDE master/slave mode selection. And provide **JVSSD** jumper to suooprt +3.3V or +5V DOM selection.

Jumper: **JCFSEL**

Type: onboard 3-pin header

JCFSEL	Mode
1-2	Master
2-3	Slave

Default setting: 2-3

Jumper: **JVSSD**

Type: onboard 3-pin header

JVSSD	Mode
1-2	+5V
2-3	+3.3V

Default setting: 1-2

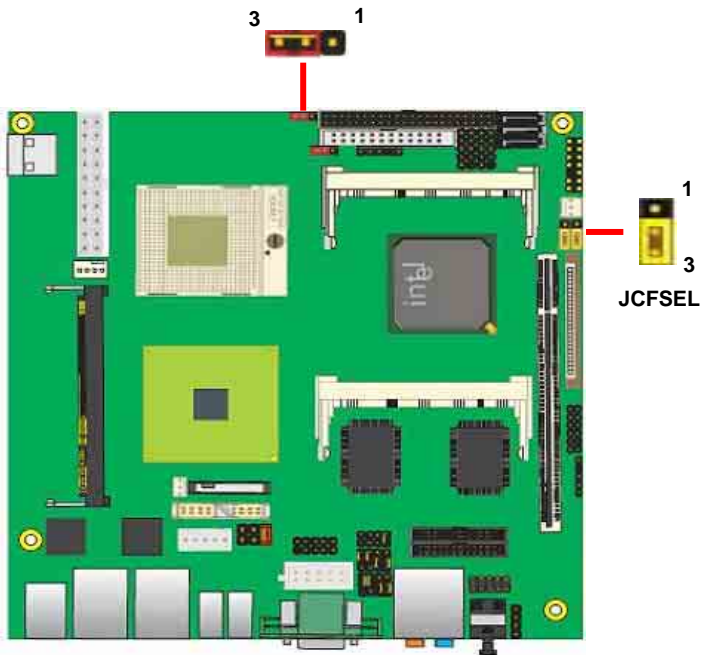

## 2.7 <Serial ATA Interface>

Based on Intel ICH8-M, the board provides two Serial ATAII interfaces with up to 300MB/s of transfer rate.

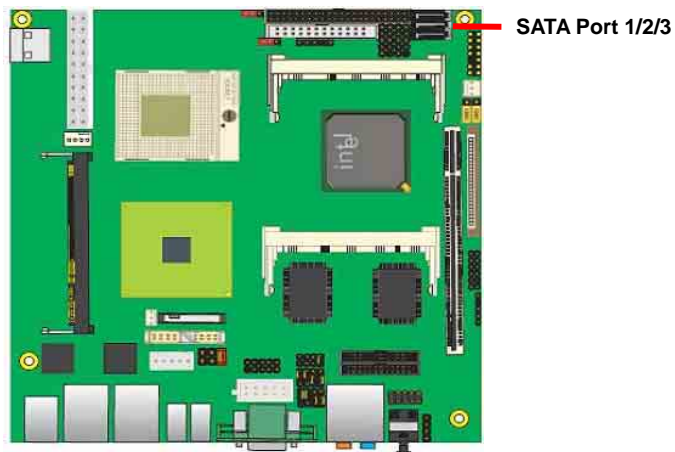

## 2.8 <Floppy Port>

The board provides one slim type floppy port.

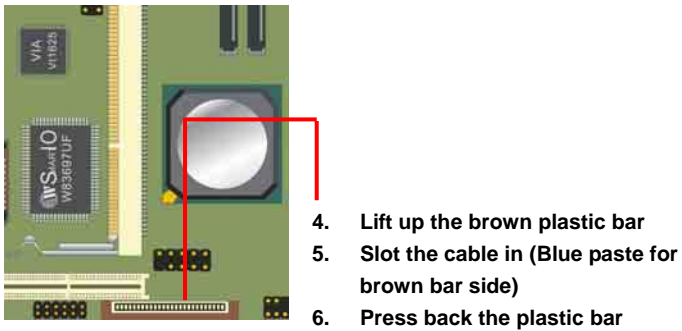
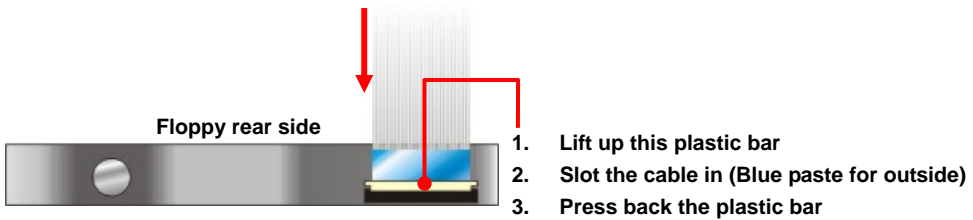
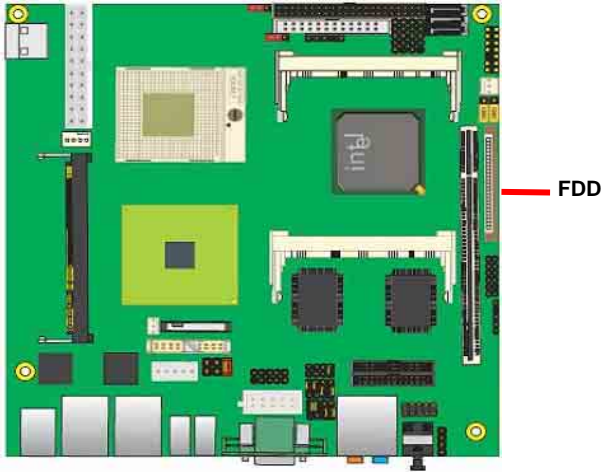



## 2.10 <Onboard Display Interface>

Based on Intel GM(E)965 chipset with built-in GMA (Graphic Media Accelerator) X3100 graphics, the board provides one DB15 connector on rear external I/O port, and one 40-pin LVDS interface with 5-pin LCD backlight inverter connector. The board provides dual display function with clone mode and extended desktop mode for CRT, LCD, TV-out and two DVI.

### 2.10.1 <Analog Display>

Please connect your CRT or LCD monitor with DB15 male connector to the onboard DB15 female connector on rear I/O port.



CRT

### 2.10.2 <Digital Display>

The board provides one 40-pin LVDS connector for 18/24-bit single/dual channel panels, supports up to 1600 x 1200 (UXGA) resolution, with one LCD backlight inverter connector and one jumper for panel voltage setting.

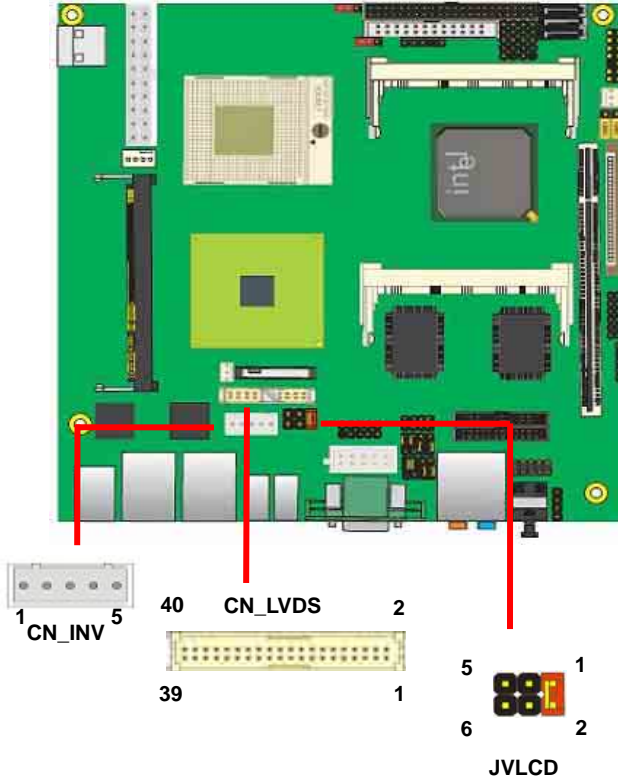

**Attention: Don't short JVLCD odd to odd pin. It could be cause serious damage.**

Connector: **CN\_INV**

Type: 5-pin LVDS Power Header

Pin	Description
1	+12V
2	Reserve
3	GND
4	GND
5	ENABKL

Connector: **JVLCD**

Type: 6-pin Power select Header

Pin	Description
1-2	LCDVCC <b>(3.3V)</b>
3-4	LCDVCC <b>(5V)</b>
5-6	LCDVCC <b>(12V)</b>

Connector: **CN\_LVDS**

Type: onboard 40-pin connector for LVDS connector

Connector model: **HIROSE DF13-40DP-1.25V**

Pin	Signal	Pin	Signal
2	LCDVCC	1	LCDVCC
4	GND	3	GND
6	ATX0-	5	BTX0-
8	ATX0+	7	BTX0+
10	GND	9	GND
12	ATX1-	11	BTX1-
14	ATX1+	13	BTX1+
16	GND	15	GND
18	ATX2-	17	BTX2-
20	ATX2+	19	BTX2+
22	GND	21	GND
24	ACLK-	23	BTX3-
26	ACLK+	25	BTX3+
28	GND	27	GND
30	ATX3-	29	BCLK-
32	ATX3+	31	BCLK+
34	GND	33	GND
36	DDCPCLK	35	N/C
38	DDCPDATA	37	N/C
40	N/C	39	N/C

## 2807750 User's Manual

---

To setup the LCD, you need the component below:

1. A panel with LVDS interfaces.
2. An inverter for panel's backlight power.
3. A LCD cable and an inverter cable.

For the cables, please follow the pin assignment of the connector to make a cable, because every panel has its own pin assignment, so we do not provide a standard cable; please find a local cable manufacture to make cables.

### LCD Installation Guide:

1. Preparing the **2807750**, LCD panel and the **backlight inverter**.

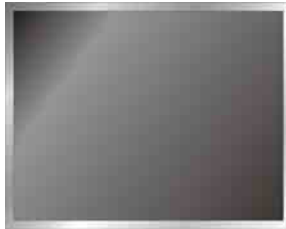
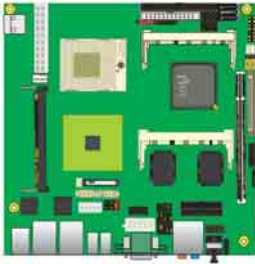

2. Please check the datasheet of the panel to see the voltage of the panel, and set the jumper **JVLCD** to +12V or +5V or +3.3V.
3. You would need a LVDS type cable.



4. To connect all of the devices well.

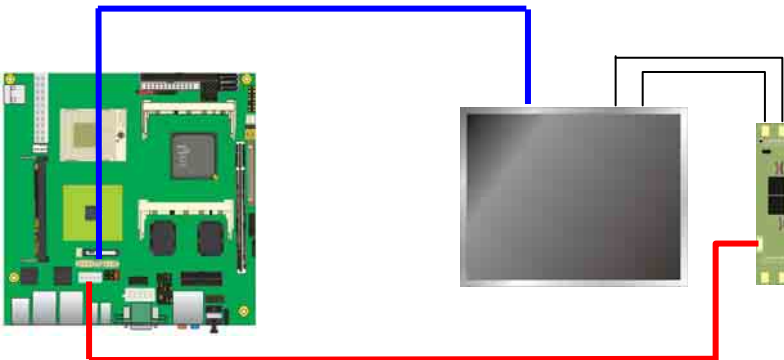

After setup the devices well, you need to select the LCD panel type in the BIOS.

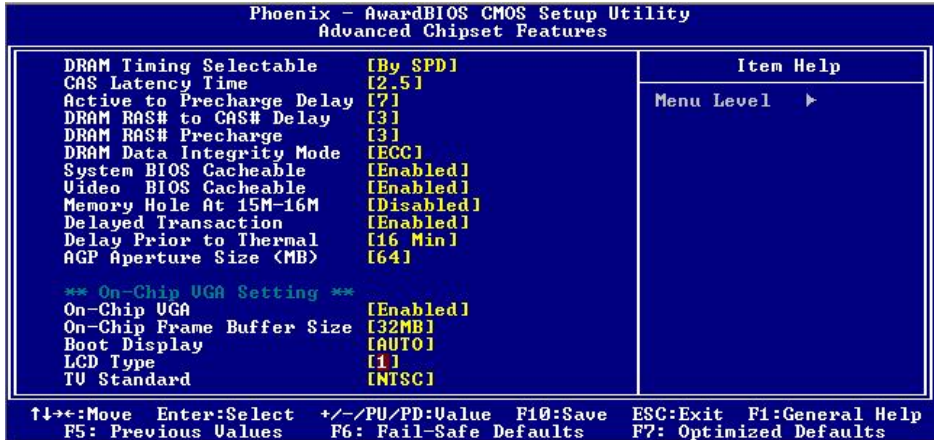

The panel type mapping is list below:

BIOS panel type selection form (BIOS Version:1.0)			
18-bit Single channel		24-bit Dual channel	
NO.	Output format	NO.	Output format
1	800 x 480	10	1024 x 768
2	800 x 600	11	1280 x 768
3	1024 x 768	12	1280 x 1024
<b>24-bit Single channel</b>		13	1366 x 768
4	1024 x 768	14	1400 x 1050 @ 108Mhz
5	1280 x 768	15	1600 x 1200
6	1280 x 800		
7	1280 x 1024		
8	1366 x 768		
9	1600 x 1200		

### 2.10.3 <HDTV Interface>

The board provides an HDTV interface with Intel GM(E) 965, supports Composite, S-Video and Component with PAL and NTSC of TV system, and display (clone or extended desktop) function with CRT,LVDS,DVI.

Connector: **CN\_HDTV**

Connector type: 10-pin header HDTV connector (pitch = 2.54mm)

Pin Number	Assignment	Pin Number	Assignment
1	GND	2	DACB1
3	DACB2	4	GND
5	GND	6	N/C
7	DACB3	8	GND
9	N/C	10	N/C

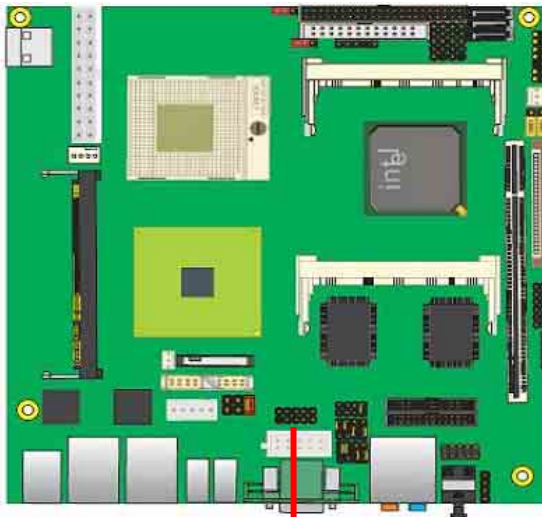

CN\_HDTV

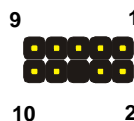

## 2.11 <Integrated Audio Interface>

The board integrates onboard audio interface with REALTEK ALC888 codec, with Intel next generation of audio standard as High Definition Audio, it offers more sound and other advantages than former AC97 audio compliance.

The main specifications of ALC888 are:

- **High-performance DACs with 100dB S/N ratio**
- **8 DAC channels support 16/20/24-bit PCM format for 5.1 audio solution**
- **16/20/24-bit S/PDIF-OUT supports 44.1K/48K/96kHz sample rate**
- **Compatible with AC'97**
- **Meets Microsoft WHQL/WLP 2.0 audio requirements**

The board provides 5.1 channels audio phone jacks on rear I/O port, and amplified speaker out and Line-in/MIC-in ports for front I/O panel through optional cable.

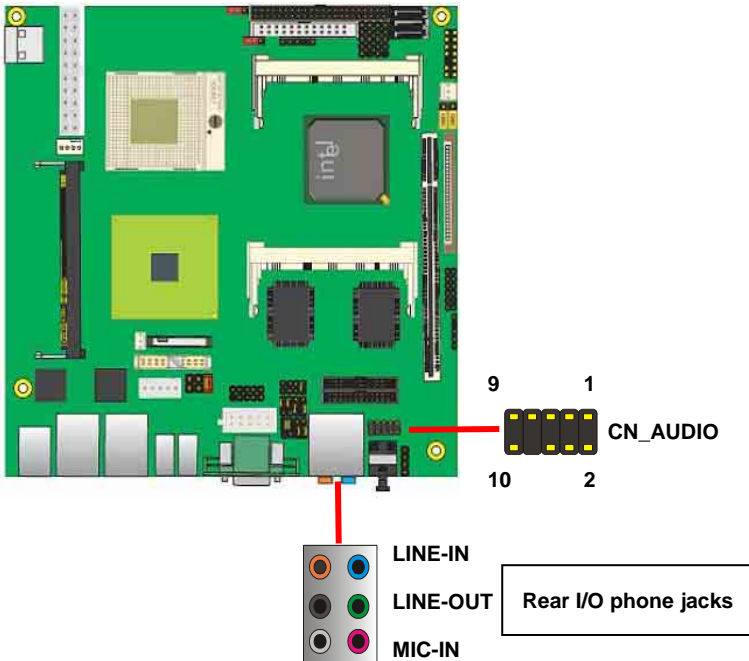

**Connector: CN\_AUDIO**

Type: 10-pin (2 x 5) 1.27mm x 2.54mm-pitch header

Pin	Description	Pin	Description
1	MIC_L	2	Ground
3	MIC_R	4	Reserve
5	Speaker_R	6	MIC Detect
7	SENSE	8	N/C
9	Speaker_L	10	Speaker Detect

**Connector: CDIN**

Type: 4-pin header (pitch = 2.54mm)

Pin	Description
1	CD – Left
2	Ground
3	Ground
4	CD – Right

## 2.12 <GPIO Interface>

The board provides a programmable 8-bit digital I/O interface; you can use this general purpose I/O port for system control like POS or KIOSK.

Connector: **CN\_DIO**

Type: 12-pin (6 x 2) 1.27mm x 2.54mm-pitch header

Pin	Description	Pin	Description
1	Ground	2	Ground
3	GP10	4	GP14
5	GP11	6	GP15
7	GP12	8	GP16
9	GP13	10	GP17
11	VCC	12	+12V

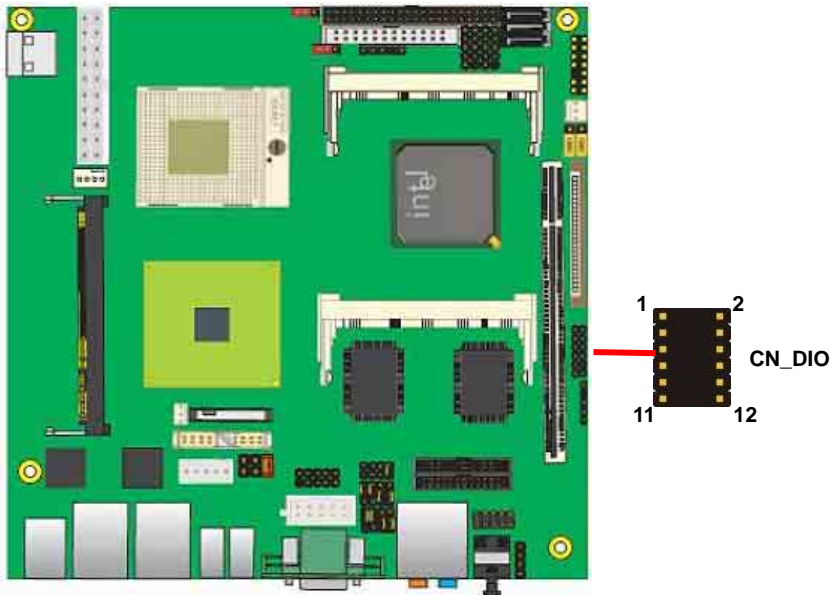

## 2.13 <Power Supply>

### 2.13.1 <Power Input>

The board requires DC 12V input with onboard 2-pin DC-input connector

the input voltage range is from 8V to 30V, or onboard 20-pin ATX2.0, for the input current, please take a reference of the power consumption report on appendix.

Connector: **DC\_IN**

Type: 4-pin DC power connector

Pin	Description	Pin	Description
1	+12V	2	Ground

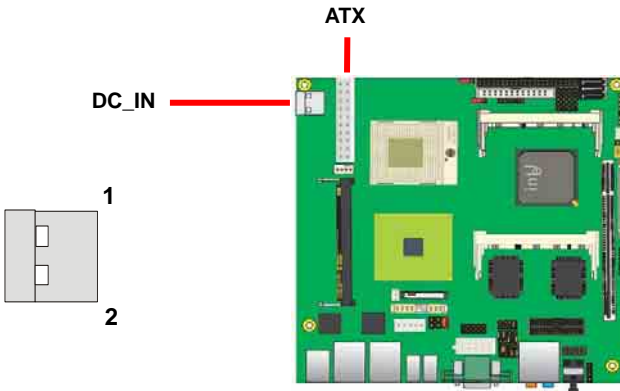

#### ▪ DC Input Mode

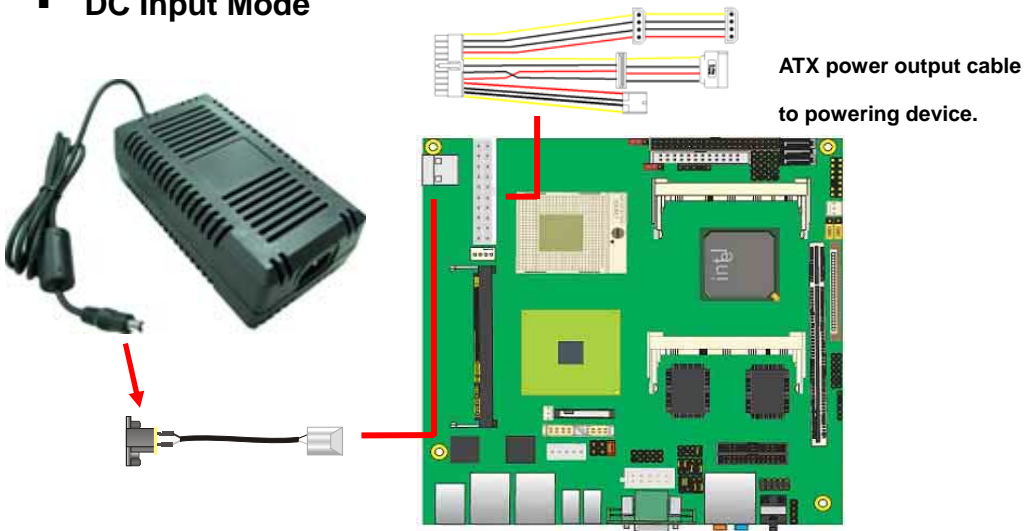

Connector: **ATX** (It also can become Output when DC-IN be used)  
Type: 20-pin ATX power connector

PIN assignment			
1	3.3V	11	3.3V
2	3.3V	12	-12V
3	GND	13	GND
4	5V	14	PS_ON
5	GND	15	GND
6	5V	16	GND
7	GND	17	GND
8	PW_OK	18	-5V
9	5V_SB	19	5V
10	12V	20	5V

▪ **ATX Power Mode**

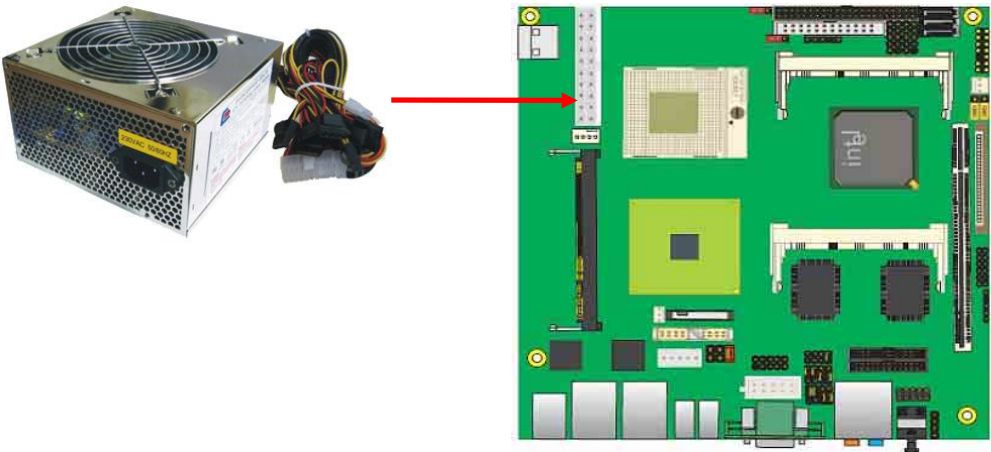

## 2.13.2 <Power Output>

The board provides one 20-pin ATX connector for +5V/+12V output for powering your HDD, CDRROM or other devices when DC-input mode has been used.

**Attention: When DC-IN had power supplied, the ATX become output !**

**Avoid DC-IN and ATX power supply input at the same time !**

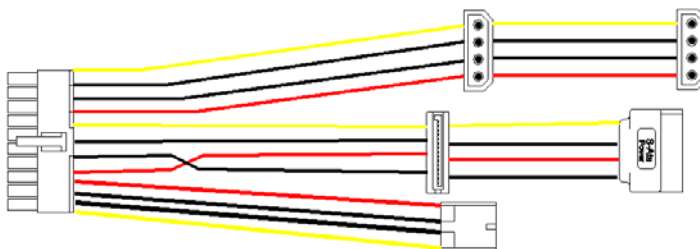

Connector: **ATX Output** (When DC-IN be used)

Type: 20-pin ATX connector for +5V/+12V

PIN assignment			
1	*	13	*
2	*	14	*
3	*	15	*
4	5V	16	*
5	GND	17	*
6	*	18	GND
7	GND	19	GND
8	*	20	*
9	*	21	*
10	12V	22	5V

Note: Maximum output voltage: 12V/5A & 5V/3A

“ \* ” **Mean don't connection**

## 2.14 <Switch and Indicator>

The **JFRNT** provides front control panel of the board, such as power button, reset and beeper, etc. Please check well before you connecting the cables on the chassis.

Connector: **JFRNT**

Type: onboard 14-pin (2 x 7) 2.54-pitch header

Function	Signal	PIN		Signal	Function
IDE LED	HDLED+	1	2	PWRLED+	Power LED
	HDLED-	3	4	N/C	
Reset	Reset+	5	6	PWRLED-	Speaker
	Reset-	7	8	SPK+	
N/C		9	10	N/C	
Power Button	PWRBT-	11	12	N/C	
	PWRBT+	13	14	SPK-	

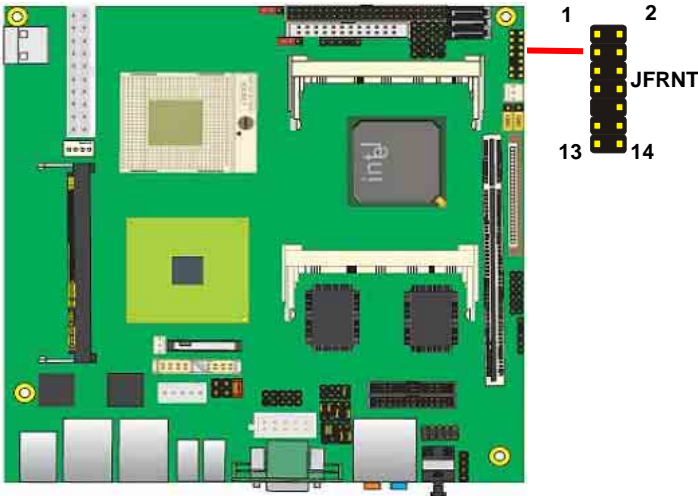

## Chapter 3 <System Setup>

### 3.1 <Audio Configuration>

The board integrates Intel® ICH8DO with REALTEK® ALC888 codec. It can support 2-channel or 7.1 channel sound under system configuration. Please follow the steps below to setup your sound system.

1. Install REALTEK HD Audio driver.
2. Lunch the control panel and Sound Effect Manager.



3. Select Speaker Configuration



4. Select the sound mode to meet your speaker system.

## 3.2 <Video Memory Setup>

Based on Intel® GM(E)965 chipset with GMA (Graphic Media Accelerator) X3100, the board supports Intel® DVMT (Dynamic Video Memory Technology) 4.0, which would allow the video memory to be allocated up to 384MB.

To support DVMT, you need to install the Intel GMA X3100 Driver with supported OS.

### BIOS Setup:

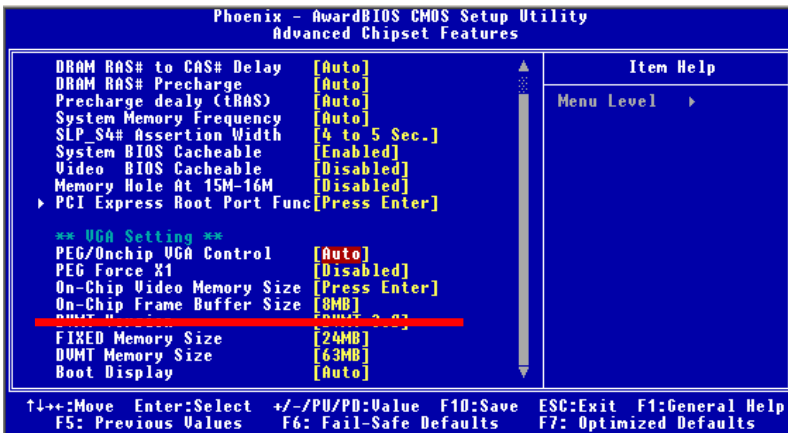

**On-Chip Video Memory Size:** This option combines three items below for setup.

#### On-Chip Frame Buffer Size:

This item can let you select video memory which been allocated for legacy VGA and SVGA graphics support and compatibility. The available option is **1MB** and **8MB**.

#### Fixed Memory Size:

This item can let you select a static amount of page-locked graphics memory which will be allocated during driver initialization. Once you select the memory amount, it will be no longer available for system memory.

#### DVMT Memory Size:

This item can let you select a maximum size of dynamic amount usage of video memory, the system would configure the video memory depends on your application, this item is strongly recommend to be selected as **MAX DVMT**.

**Fixed + DVMT Memory Size:**

You can select the fixed amount and the DVMT amount at the same time for a guaranteed video memory and additional dynamic video memory, please check the table below for available setting.

System Memory	On-Chip Frame Buffer Size	Fixed Memory Size	DVMT Memory Size	Total Graphic Memory
256MB ~ 511MB	1MB	128MB	0MB	128MB
	1MB	0MB	128MB	128MB
	8MB	128MB	0MB	128MB
	8MB	0	128MB	128MB
512MB~1023MB	1MB	128MB	0	128MB
	1MB	256MB	0	256MB
	1MB	0	128MB	128MB
	1MB	0	256MB	256MB
	8MB	128MB	0	128MB
	8MB	256MB	0	256MB
	8MB	0	128MB	128MB
	8MB	0	256MB	256MB
1024MB upper	1MB	128MB	0	128MB
	1MB	256MB	0	256MB
	1MB	0	128MB	128MB
	1MB	0	256MB	256MB
	1MB	0	MAX	384MB
	8MB	128MB	0	128MB
	8MB	256MB	0	256MB
	8MB	0	128MB	128MB
	8MB	0	256MB	256MB
	8MB	0	MAX	384MB

Notice:

1. The On-Chip Frame Buffer Size would be included in the Fixed Memory.

Please select the memory size according to this table.

### 3.3 <Display Properties Setting>

Based on Intel GM(E)965 GMCH with GMA X3100 (Graphic Media Accelerator), the board supports two DACs for display device as different resolution and color bit.

Please install the Intel Graphic Driver before you starting setup display devices.

1. Click right button on the desktop to lunch **display properties**

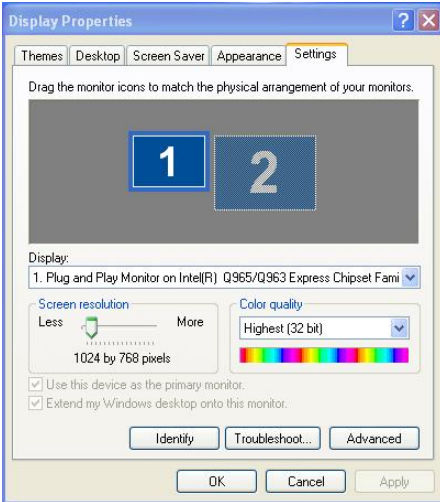

2. Click **Advanced** button for more specificity setup.

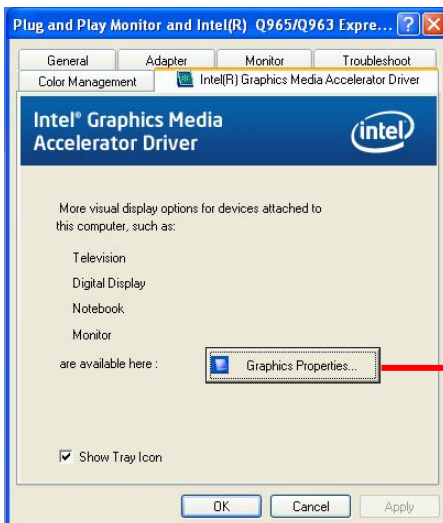

Click **Graphics Properties...** for advanced setup

3. This setup options can let you define each device settings.

Click **Monitor** to setup the CRT monitor for Colors, Resolution and Refresh Rate

Click **Intel® Dual Display Clone** to setup the dual display mode as same screen

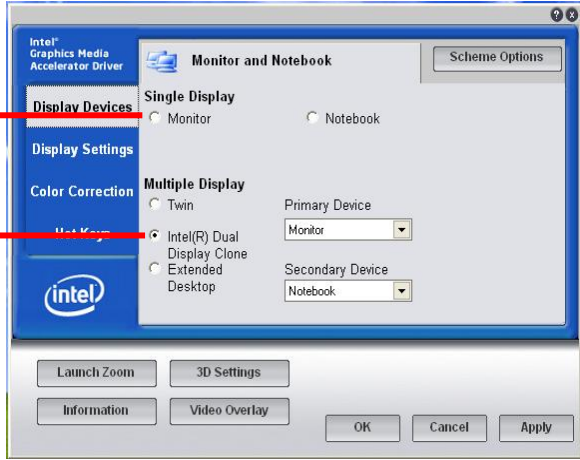

(This page is left for blank)

(This page is left for blank)

## Appendix A <I/O Port Pin Assignment>

### A.1 <IDE Port>

Connector: IDE1

Type: 44-pin (22 x 2) box header

Pin	Description	Pin	Description
1	Reset	2	Ground
3	D7	4	D8
5	D6	6	D9
7	D5	8	D10
9	D4	10	D11
11	D3	12	D12
13	D2	14	D13
15	D1	16	D14
17	D0	18	D15
19	Ground	20	N/C
21	REQ	22	Ground
23	-IOW	24	Ground
25	-IOR	26	Ground
27	IRDY	28	Ground
29	DACK	30	Ground
31	IDEIRQ	32	N/C
33	A1	34	66DET
35	A0	36	A2
37	-CS1	38	-CS3
39	-HD LED1	40	Ground
41	<b>By JVSSD Jumper</b>	42	<b>By JVSSD Jumper</b>
43	Ground	44	Ground

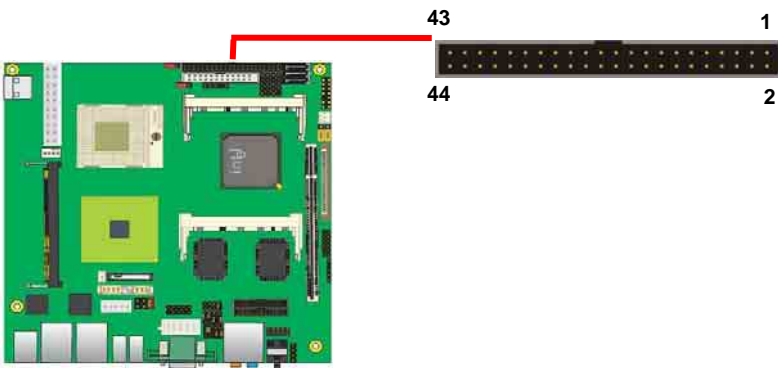

## A.2 <Serial ATA Port>

Connector: **SATA1/2**

Type: 7-pin wafer connector

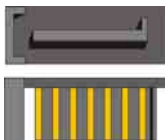

1	2	3	4	5	6	7	8	9
GND	RSATA_TXP1	RSATA_TXN1	GND	RSATA_RXN1	RSATA_RXP1	GND	GND	GND

## A.3 <Floppy Port>

Connector: **FDD**

Type: 26-pin connector



Pin	Description	Pin	Description
1	VCC	2	INDEX
3	VCC	4	DR0
5	VCC	6	DSKCHG
7	N/C	8	N/C
9	N/C	10	MTR0
11	DRVDE0	12	DIR
13	N/C	14	STEP
15	Ground	16	WRITE DATA
17	Ground	18	WRITE GATE
19	Ground	20	TRAK 0
21	N/C	22	WRPT0
23	Ground	24	RDATA-
25	Ground	26	HDSEL

## A.4 <IrDA Port>

Connector: **CN\_IR**

Type: 5-pin header for SIR Ports

*JCSEL1 must jump to "IrDA"*

Pin	Description
1	VCC
2	N/C
3	IRRX
4	Ground
5	IRTX



## A.5 <Serial Port 1>

Connector: **COM1**

Type: 9-pin D-sub male connector on bracket



Pin	Description	Pin	Description
1	DCD- /+5V	6	DSR
2	SIN-	7	RTS
3	SO-	8	CTS
4	DTR-	9	RI /+12V
5	Ground		

## A.6 <Serial Port 2>

Connector: **COM2**

Type: 9-pin header connector on bracket

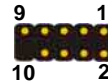

Pin	Description	Pin	Description
1	DCD- /485- /+5V	6	DSR
2	SIN- /485+	7	RTS
3	SO- /422+	8	CTS
4	DTR- /422-	9	RI /+12V
5	Ground		

## A.7 <Parallel Port>

Connector: **LPT**

Type: 26-Pin header Connector on bracket

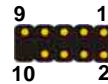

Pin	Description	Pin	Description
1	-PSTB	2	PRO0
3	PRO1	4	PRO2
5	PRO3	6	PRO4
7	PRO5	8	PRO6
9	PRO7	10	ACK-
11	BUSY	12	PE
13	SLCT	14	AFD-
15	ERR-	16	INT-
17	SLIN-	18	Ground
19	Ground	20	I/O Ground
21	Ground	22	Ground
23	Ground	24	Ground
25	Ground	26	N/C

## A.8 <VGA Port>

Connector: **CRT**

Type: 15-pin D-sub female connector on bracket

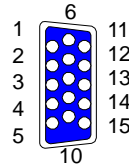

Pin	Description	Pin	Description	Pin	Description
1	RED	6	Ground	11	N/C
2	GREEN	7	Ground	12	DDCDA
3	BLUE	8	Ground	13	HSYNC
4	N/C	9	N/C	14	VSYNC
5	Ground	10	Ground	15	DDCCLK

## A.9 <LAN Port>

Connector: **RJ45**

Type: RJ45 connector with LED on bracket



Pin	1	2	3	4	5	6	7	8
Description	MIO+	MIO-	MI1+	MI2+	MI2-	MI1-	MI3+	MI3-

## A.10 < USB Interface >

Connector: **CN\_USB**

Type: 10-pin (5 x 2) header for dual USB Ports

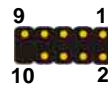























































Pin	Description	Pin	Description
1	VCC	2	VCC
3	Data0-	4	Data1-
5	Data0+	6	Data1+
7	Ground	8	Ground
9	Ground	10	N/C

(This page is left for blank)































## Appendix C <System Resources>

### C1. <I/O Port Address Map>

	[00000000 - 0000000F] Direct memory access controller
	[00000000 - 00000CF7] PCI bus
	[00000010 - 0000001F] Motherboard resources
	[00000020 - 00000021] Programmable interrupt controller
	[00000022 - 0000003F] Motherboard resources
	[00000040 - 00000043] System timer
	[00000044 - 0000005F] Motherboard resources
	[00000060 - 00000060] Standard 101/102-Key or Microsoft Natural PS/2 Keyboard
	[00000061 - 00000061] System speaker
	[00000062 - 00000063] Motherboard resources
	[00000064 - 00000064] Standard 101/102-Key or Microsoft Natural PS/2 Keyboard
	[00000065 - 0000006F] Motherboard resources
	[00000070 - 00000073] System CMOS/real time clock
	[00000074 - 0000007F] Motherboard resources
	[00000080 - 00000090] Direct memory access controller
	[00000091 - 00000093] Motherboard resources
	[00000094 - 0000009F] Direct memory access controller
	[000000A0 - 000000A1] Programmable interrupt controller
	[000000A2 - 000000BF] Motherboard resources
	[000000C0 - 000000DF] Direct memory access controller
	[000000E0 - 000000EF] Motherboard resources
	[000000F0 - 000000FF] Numeric data processor
	[00000170 - 00000177] Secondary IDE Channel
	[000001F0 - 000001F7] Primary IDE Channel
	[00000274 - 00000277] ISAPNP Read Data Port
	[00000279 - 00000279] ISAPNP Read Data Port
	[000002F8 - 000002FF] Communications Port (COM2)
	[00000376 - 00000376] Secondary IDE Channel
	[00000378 - 0000037F] Printer Port (LPT1)
	[000003B0 - 000003BB] Mobile Intel(R) 965 Express Chipset Family
	[000003C0 - 000003DF] Mobile Intel(R) 965 Express Chipset Family
	[000003F0 - 000003F5] Standard floppy disk controller
	[000003F6 - 000003F6] Primary IDE Channel
	[000003F7 - 000003F7] Standard floppy disk controller
	[000003F8 - 000003FF] Communications Port (COM1)
	[00000400 - 000004BF] Motherboard resources
	[000004D0 - 000004D1] Motherboard resources
	[00000500 - 0000051F] Intel(R) ICH8 Family SMBus Controller - 283E

	[00000680 - 000006FF] Motherboard resources
	[00000778 - 0000077B] Printer Port (LPT1)
	[00000880 - 0000088F] Motherboard resources
	[00000A79 - 00000A79] ISAPNP Read Data Port
	[00000D00 - 0000FFFF] PCI bus
	[0000C000 - 0000CFFF] Intel(R) ICH8 Family PCI Express Root Port 1 - 283F
	[0000CFE0 - 0000CFFF] Intel(R) PRO/1000 PL Network Connection #2
	[0000D000 - 0000DFFF] Intel(R) ICH8 Family PCI Express Root Port 2 - 2841
	[0000DFE0 - 0000DFFF] Intel(R) PRO/1000 PL Network Connection
	[0000F300 - 0000F30F] Intel(R) ICH8M 3 port Serial ATA Storage Controller - 2828
	[0000F400 - 0000F40F] Intel(R) ICH8M 3 port Serial ATA Storage Controller - 2828
	[0000F500 - 0000F503] Intel(R) ICH8M 3 port Serial ATA Storage Controller - 2828
	[0000F600 - 0000F607] Intel(R) ICH8M 3 port Serial ATA Storage Controller - 2828
	[0000F700 - 0000F703] Intel(R) ICH8M 3 port Serial ATA Storage Controller - 2828
	[0000F800 - 0000F807] Intel(R) ICH8M 3 port Serial ATA Storage Controller - 2828
	[0000F900 - 0000F90F] Intel(R) ICH8M Ultra ATA Storage Controllers - 2850
	[0000FA00 - 0000FA1F] Intel(R) ICH8 Family USB Universal Host Controller - 2832
	[0000FB00 - 0000FB1F] Intel(R) ICH8 Family USB Universal Host Controller - 2831
	[0000FC00 - 0000FC1F] Intel(R) ICH8 Family USB Universal Host Controller - 2830
	[0000FD00 - 0000FD1F] Intel(R) ICH8 Family USB Universal Host Controller - 2835
	[0000FE00 - 0000FE1F] Intel(R) ICH8 Family USB Universal Host Controller - 2834
	[0000FF00 - 0000FF07] Mobile Intel(R) 965 Express Chipset Family

## C2. <Memory Address Map>

















	[00000000 - 0009FFFF] System board
	[000A0000 - 000BFFFF] Mobile Intel(R) 965 Express Chipset Family
	[000A0000 - 000BFFFF] PCI bus
	[000C0000 - 000DFFFF] PCI bus
	[000E0000 - 000EFFFF] System board
	[000F0000 - 000FFFFF] System board
	[00100000 - 0F6DFFFF] System board
	[0F6E0000 - 0F6FFFFF] System board
	[0F700000 - 0F7FFFFF] System board
	[0F700000 - FEBFFFFF] PCI bus
	[D0000000 - DFFFFFFF] Mobile Intel(R) 965 Express Chipset Family
	[E0000000 - EFFFFFFF] Motherboard resources
	[FD700000 - FD7FFFFF] Mobile Intel(R) 965 Express Chipset Family
	[FDA00000 - FDAFFFFFFF] Mobile Intel(R) 965 Express Chipset Family
	[FDB00000 - FDBFFFFF] Intel(R) ICH8 Family PCI Express Root Port 2 - 2841
	[FDC00000 - FDCFFFFFFF] Intel(R) ICH8 Family PCI Express Root Port 2 - 2841
	[FDCE0000 - FDCFFFFFFF] Intel(R) PRO/1000 PL Network Connection
	[FDD00000 - FDDFFFFFFF] Intel(R) ICH8 Family PCI Express Root Port 1 - 283F
	[FDE00000 - FDEFFFFFFF] Intel(R) ICH8 Family PCI Express Root Port 1 - 283F
	[FDEE0000 - FDEFFFFFFF] Intel(R) PRO/1000 PL Network Connection #2
	[FDFF4000 - FDFF7FFF] Microsoft UAA Bus Driver for High Definition Audio
	[FDFFD000 - FDFFD0FF] Intel(R) ICH8 Family SMBus Controller - 283E
	[FDFFE000 - FDFFE3FF] Intel(R) ICH8 Family USB2 Enhanced Host Controller - 2836
	[FDFFF000 - FDFFF3FF] Intel(R) ICH8 Family USB2 Enhanced Host Controller - 283A
	[FEC00000 - FEC00FFF] System board
	[FED14000 - FED1DFFF] System board
	[FED20000 - FED9FFFF] System board
	[FEE00000 - FEE00FFF] System board
	[FFB00000 - FFB7FFFF] System board
	[FFB80000 - FFBFFFFF] Intel(R) 82802 Firmware Hub Device
	[FFF00000 - FFFFFFFF] System board

## C3. <System IRQ & DMA Resources>

### DMA:

-  2 Standard floppy disk controller
-  4 Direct memory access controller

### IRQ:

-  (ISA) 0 System timer
-  (ISA) 1 Standard 101/102-Key or Microsoft Natural PS/2 Keyboard
-  (ISA) 3 Communications Port (COM2)
-  (ISA) 4 Communications Port (COM1)
-  (ISA) 6 Standard floppy disk controller
-  (ISA) 8 System CMOS/real time clock
-  (ISA) 9 Microsoft ACPI-Compliant System
-  (ISA) 13 Numeric data processor
-  (ISA) 14 Primary IDE Channel
-  (ISA) 15 Secondary IDE Channel
-  (PCI) 11 Intel(R) ICH8 Family SMBus Controller - 283E
-  (PCI) 16 Intel(R) ICH8 Family PCI Express Root Port 1 - 283F
-  (PCI) 16 Intel(R) ICH8 Family USB Universal Host Controller - 2834
-  (PCI) 16 Intel(R) PRO/1000 PL Network Connection #2
-  (PCI) 16 Mobile Intel(R) 965 Express Chipset Family
-  (PCI) 17 Intel(R) ICH8 Family PCI Express Root Port 2 - 2841
-  (PCI) 17 Intel(R) PRO/1000 PL Network Connection
-  (PCI) 18 Intel(R) ICH8 Family USB Universal Host Controller - 2832
-  (PCI) 18 Intel(R) ICH8 Family USB2 Enhanced Host Controller - 283A
-  (PCI) 19 Intel(R) ICH8 Family USB Universal Host Controller - 2831
-  (PCI) 19 Intel(R) ICH8M 3 port Serial ATA Storage Controller - 2828
-  (PCI) 21 Intel(R) ICH8 Family USB Universal Host Controller - 2835
-  (PCI) 22 Microsoft UAA Bus Driver for High Definition Audio
-  (PCI) 23 Intel(R) ICH8 Family USB Universal Host Controller - 2830
-  (PCI) 23 Intel(R) ICH8 Family USB2 Enhanced Host Controller - 2836

---

## Appendix D <Programming GPIO's>

The GPIO can be programmed with the MSDOS debug program using simple IN/OUT commands. The following lines show an example how to do this.

```
GPIO0.....GPIO7  bit0.....bit7
-o 2 E 87                ;enter configuration
-o 2E 87
-o 2E 07
-o 2F 09                ;enale GPIO function
-o 2E 30
-o 2F 02                ;enable GPIO configuration
-o 2E F0
-o 2F xx                ;set GPIO as input/output; set '1' for input,'0' for
output
-o 2E F1
-o 2F xx                ;if set GPIO's as output,in this register its value
can be set
```

Optional :

```
-o 2E F2
-o 2F xx                ; Data inversion register ; '1' inverts the current
                        valus of the bits ,'0' leaves them as they are
-o 2E 30
-o 2F 01                ; active GPIO's
```

For further information ,please refer to Winbond W83627DHG datasheet.

## Appendix E <Programming Watchdog Timer >

The watchdog timer makes the system auto-reset while it stops to work for a period. The integrated watchdog timer can be setup as system reset mode by program.

### Timeout Value Range

- 1 to 255
- Second or Minute

### Program Sample

Watchdog timer setup as system reset with 5 second of timeout

---

```

2E, 87
2E, 87
2E, 07
2F, 08      Logical Device 8
2E, 30      Activate
2F, 01
2E, F5      Set as Second*
2F, 00
2E, F6      Set as 5
2F, 05
    
```

---

\* Minute: bit 3 = 0; Second: bit 3 = 1

You can select Timer setting in the BIOS, after setting the time options, the system will reset according to the period of your selection.



**Appendix F <How to setting RS-422,RS-485 & IrDA>**

Function	JCSEL1	JCSEL2
IrDA		
RS-422		
RS-485		
RS-232		

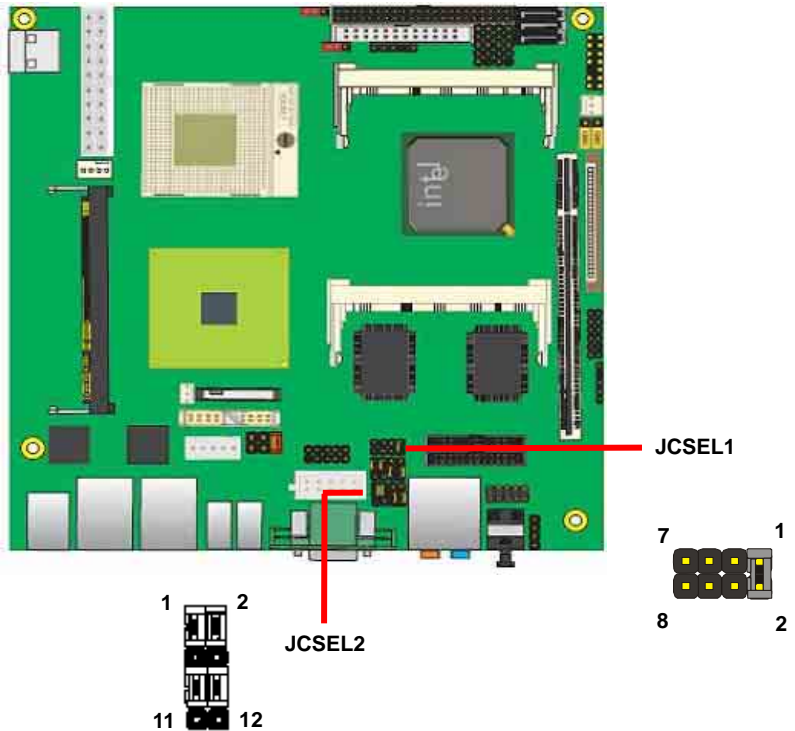

---

Any advice or comments about our products and service, or anything we can help you with please don't hesitate to contact with us. We will do our best to support your products, projects and business.



Address: Global American, Inc.  
17 Hampshire Drive  
Hudson, NH 03051

Telephone: Toll Free (U.S. Only) 800-833-8999  
(603)886-3900

FAX: (603)886-4545

Website: <http://www.globalamericaninc.com>

E-Mail: [salesinfo@globalamericaninc.com](mailto:salesinfo@globalamericaninc.com)

---