

3907627

3907628

3907599

Quick Reference

Edition 1.1

2005/04/11



Copyright

Copyright© 2004 - 2005. All rights reserved. This document is copyrighted and all rights are reserved. The information in this document is subject to change without prior notice to make improvements to the products.

This document contains proprietary information and protected by copyright. No part of this document may be reproduced, copied, or translated in any form or any means without prior written permission of the manufacturer.

All trademarks and/or registered trademarks contains in this document are property of their respective owners.

Disclaimer

Global American Inc.. shall not be liable for any incidental or consequential damages resulting from the performance or use of this product. Global American Inc. does not issue a warranty of any kind, express or implied, including without limitation implied warranties of merchantability or fitness for a particular purpose.

The company has the right to revise the manual or include changes in the specifications of the product described within it at any time without notice and without obligation to notify any person of such revision or changes.

Trademark

All trademarks are the property of their respective holders.

Any questions please visit our website at <http://www.globalamericaninc.com>.

1 < Product Specifications >

3907599

Form Factor	Mini-AGP form factor with 875mm x 675mm (H x W)
Controller	CHRONTEL CH7017A-T
Display output	18/24-bit single/dual channel output
Accessories	None

3907627

Form Factor	Mini-AGP form factor with 875mm x 675mm (H x W)
Controller	CHRONTEL CH7301C-T
Display output	Up to 2048 x 1536 of resolution
Accessories	26-pin to 26-pin female cable x 1 DVI output module x 1

3907628

Form Factor	Mini-AGP form factor with 875mm x 675mm (H x W)
Controller	CHRONTEL CH7015A-D
Display output	TV-out for up to 1024 x 768 of resolution NTSC/PAL mode supported
Accessories	RCA/S-Video output cable for TV-out x 1

2 < Connectors & Jumpers Location >

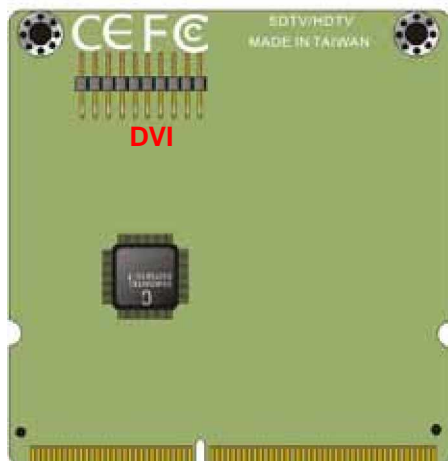

3907627

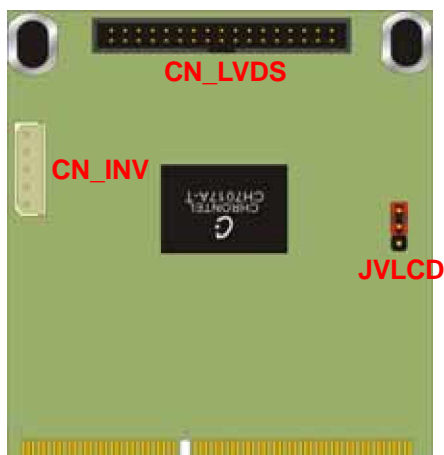

3907599

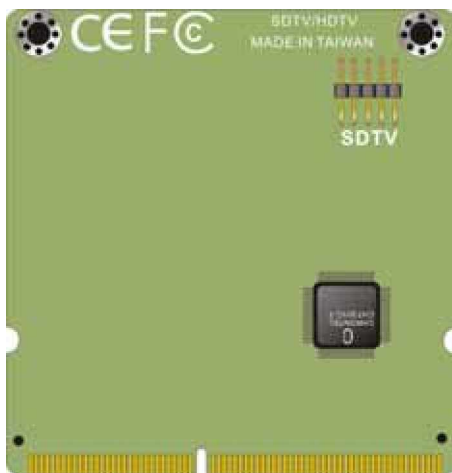

3907628

3 < Pin Assignment List >

3.1 < 3907599 >

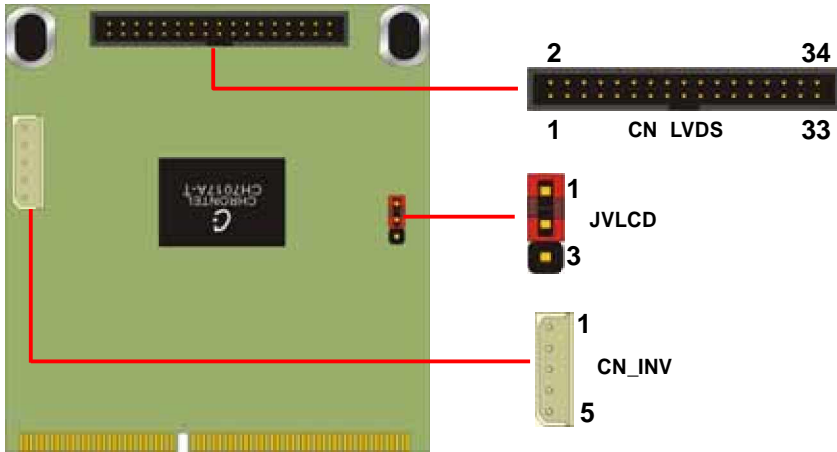

Connector: **CN_INV**

Connector Type: onboard 5-pin header

Pin	Description
1	+12V
2	GND
3	GND
4	GND
5	ENABKL

Jumper: **JVLCD**

Type: onboard 3-pin header

JVLCD	Mode
1-2	+5V
2-3	+3.3V

Default setting

Connector: **CN_LVDS**

Connector Type: 2 x 17 pin housing connector

Pin	Signal	Pin	Signal
1	VCCLCD	2	VCCLCD
3	GND	4	GND
5	OTX0-	6	OTX0+
7	OTX1-	8	OTX1+
9	GND	10	GND
11	OTX2-	12	OTX2+
13	OCLK-	14	OCLK+
15	GND	16	GND
17	OTX3-	18	OTX3+
19	ETX0-	20	ETX0+
21	GND	22	GND
23	ETX1-	24	ETX1+
25	ETX2-	26	ETX2+
27	GND	28	GND
29	ECLK-	30	ECLK+
31	ETX3-	32	ETX3+
33	GND	34	GND

3.2 <3907627 >

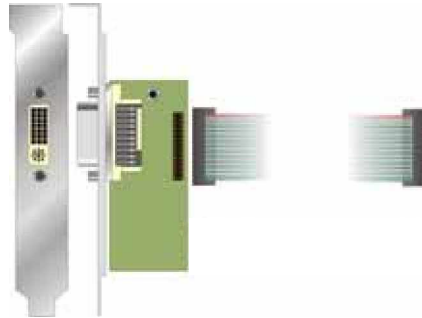
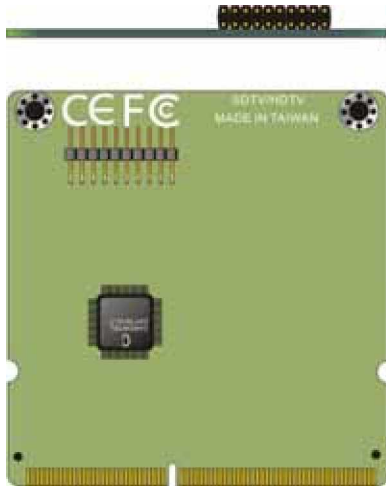

Attached DVI output module

Notice: RED line for pin1

Connector: **DVI**

Connector Type: onboard 10 x 2 pin header (2.0 mm pitch)



Pin Number	Assignment	Pin Number	Assignment
1	TDC1+	2	TDC1-
3	Ground	4	Ground
5	TLC+	6	TLC-
7	Ground	8	VCC
9	N/C	10	N/C
11	TDC2+	12	TDC2-
13	Ground	14	Ground
15	TDC0+	16	TDC0-
17	N/C	18	HPDET
19	DCCDATA	20	DCCCLK

3.3 < 3907628 >



SDTV

Ground	1	2	Y_E
C_E	3	4	Ground
Ground	5	6	Ground
CVBS_E	7	8	Ground

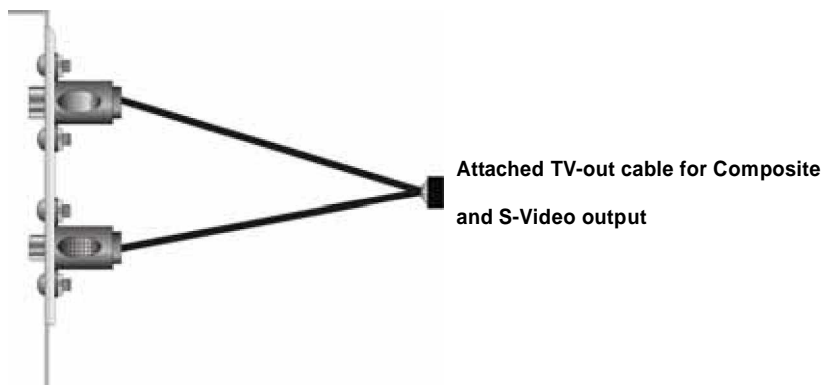

4 < Display Settings >

After you installed the hardware devices well, please install the video drivers.

For display setting under Windows OS, please follow the setups below:

1. Launch the display properties.



2. Select settings option and click Advanced Button

3. Select Intel(R) Extreme Graphics and click Graphics properties

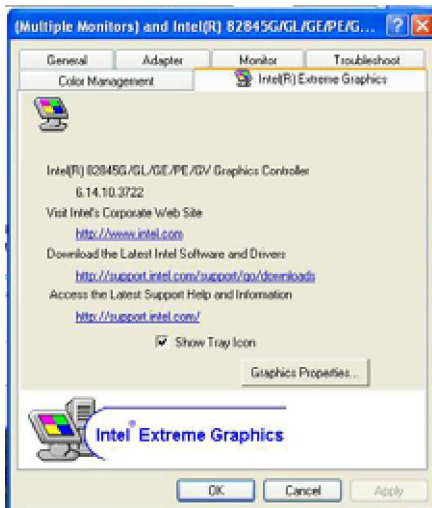

4. There will be different devices depending on whats connected to you computer

Notice: Before you can find the device you would like to use, please connect them well before you boot up the system.

For Monitor:

You can configure the Colors, Screen area (resolution) and Refresh Rate.

For Notebook:

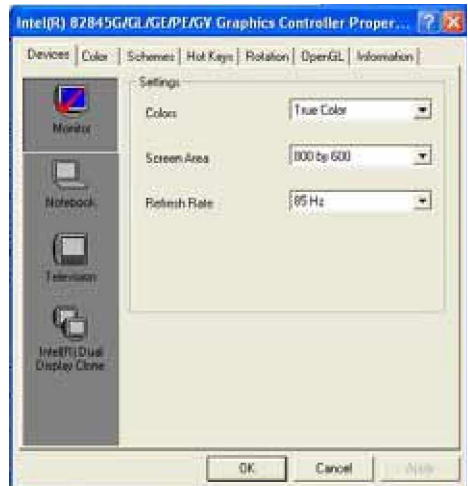

For Notebook:

If you connect a LCD panel though LVDS interface, you can configure the Colors and Screen Area (resolution) here.



For Television:

If you connect a TV set through S-Video or RCA connector here can let you configure the Colors, Screen Area (resolution) and Video Standard.



For DVI monitor:

If you connect a DVI monitor, please select this option to trigger the monitor display. Colors and Screen Area can let you select its color bits and resolution.

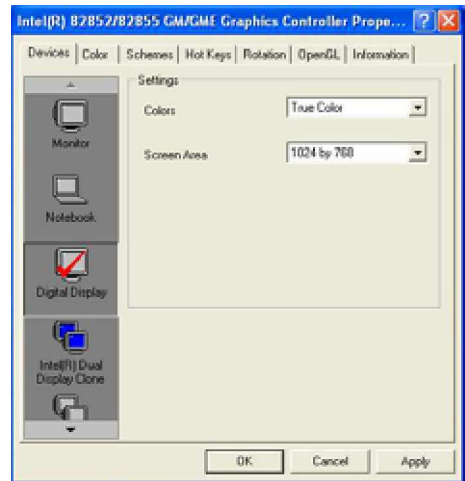

Contact Information

Any advice or comment about our products and service, or anything we can help you please don't hesitate to contact with us. We will do our best to support you for your products, projects and business.

Global American Inc

Thank you for purchasing from Global American Inc. We will stand by our slogan, *Integration with Integrity.*

Please let us know how your product is performing and if we can help you with any future product lines.

Address 17 Hampshire Drive

Hudson, NH 03051

TEL (800) 833 8999

FAX (603) 886 4545

Website <http://www.globalamericaninc.com>

E-mail salesinfo@globalamericaninc.com (Sales)

support@globalamericaninc.com (Tech Support)