



integration with integrity

User's Manual

ETX Embedded Controller 3311870

Version 1.1, June 2007



Copyrights

This manual is copyrighted and all rights are reserved. It does not allow any non authorization in copied, photocopied, translated or reproduced to any electronic or machine readable form in whole or in part without prior written consent from the manufacturer.

In general, the manufacturer will not be liable for any direct, indirect, special, incidental or consequential damages arising from the use of inability to use the product or documentation, even if advised of the possibility of such damages. The manufacturer keeps the rights in the subject to change the contents of this manual without prior notices in order to improve the function design, performance, quality and reliability. The author assumes no responsibility for any errors or omissions, which may appear in this manual, nor does it make a commitment to update the information contained herein.

Trademarks

Intel is a registered trademark of Intel Corporation.

Award is a registered trademark of Award Software, Inc.

All other trademarks, products and or product's name mentioned herein are mentioned for identification purposes only, and may be trademarks and/or registered trademarks of their respective companies or owners.

Packing List

Please check the package before you starting setup the system

Hardware:

3311870 ETX CPU Module x 1

Cable Kit:



26-pin slim type floppy cable x 1



Serial ATA ribbon cable x 2

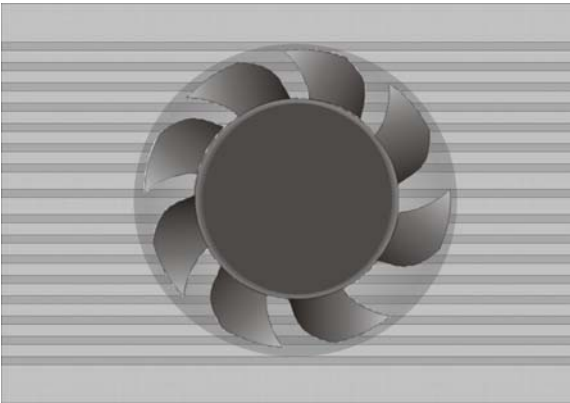

Head Sink and four screws

Other Accessories:

Divers CD (including User's Manual) x 1

Index

Chapter 1 <Introduction>	7
1.1 <Product Overview>.....	7
1.2 <Product Specification>	8
1.3 <Mechanical Drawing>.....	10
1.4 <Block Diagram>.....	11
Chapter 2 <Hardware Setup>	12
2.1 <Connector Location>.....	12
2.2 <Connector Reference>	13
2.2.1 <Internal Connector>.....	13
2.3 <CPU and Memory Setup>	14
2.3.1 < CPU>.....	14
2.3.2 <Memory>	15
2.4 <Enhanced IDE Interface>.....	16
2.5 <Serial ATA Interface>	16
2.6 <Floppy Port>.....	17
2.7 <LAN Interface>	18
2.8 <Onboard Display Interface>	18
2.9 <USB2.0 Interface>.....	19
Chapter 3 <System Configuration>	21
3.1 <Video Memory Setup>	21
Appendix A <ETX connector Assignment>	26
Appendix B <I/O Port Pin Assignment>	29
B.1 <Floppy Port>	29
B.2 <Serial ATA Port>.....	29

Appendix D <System Resources> 32

Contact Information..... 36

(The Page is Left For Blank)

Chapter 1 <Introduction>

1.1 <Product Overview>

3311870 is the new generation of the ETX CPU module, with supporting Intel Core 2 Duo/Core Duo/Core solo processors for 533/667MHz front side bus, Intel 945GME and ICH7-M chipset, integrated GMA950 graphics, DDR2 SO-Dimm SDRAM, REALTEK AC97 Audio and serial ATA with provide the economical embedded platform.

Intel Yonah dual core Processor

The board supports Intel Core 2 Duo/ Core Duo/Core Solo processors with 533/667MHz front side bus, 2MB L2 cache, to provide more powerful performance than before.

New features for Intel 945GME chipset

The board integrates Intel 945GME and ICH7-M chipset, to provide new generation of the mobile solution, supports Intel GMA950 graphics, DDR2 400/533/667 memory, built-in high speed mass storage interface of serial ATA, AC97 Audio with 5.1 channels surrounding sound.

All in One multimedia solution

Based on Intel 945GME and ICH7-M chipset, the board provides high performance onboard graphics, 24/18-bit Single/dual channel LVDS interface, 5.1 channels AC97 Audio, to meet the very requirement of the multimedia application.

1.2 <Product Specification>

General Specification

Form Factor	ETX CPU module
CPU	Intel® Core 2 Duo/ Core Duo/Core Solo processors Package type: FC-PGA478 Front side bus: 533/667MHz
Memory	1 x 200-pin DDR2 SoDIMM SDRAM up to 2GB Unbuffered, none-ECC memory supported only
Chipset	Intel® 945GME (Northbridge) and ICH7-M (Southbridge)
BIOS	Phoenix-Award v6.00PG 4Mb PnP flash BIOS
Green Function	Power saving mode includes doze, standby and suspend modes. ACPI version 1.0 and APM version 1.2 compliant
Watchdog Timer	System reset programmable watchdog timer with 1 ~ 255 sec./min. of timeout value
Real Time Clock	Intel® ICH7-M built-in RTC with lithium battery
Enhanced IDE	Support one channels & up to two IDE device Support Ultra DMA 33/66/100MHz IDE device
Serial ATA	Intel® ICH7-M integrates 2 Serial ATA interfaces(No RAID Function) Up to 150MB/s of transfer rate

Multi-I/O Port

Chipset	Intel® ICH7-M with Winbond® W83627THG controller
Serial Port	Support two Serial Port
USB Port	Support four USB 2.0 Ports
Floppy Port	One slim type Floppy port
IrDA Port	One IrDA compliant Infrared interface supports SIR
K/B & Mouse	Support PS/2 keyboard and mouse interface

VGA Display Interface

Chipset	Intel® 945GME GMCH integrate GMA 950
Frame Buffer	Up to 224MB shared with system memory
Display Type	Onboard 18-bit & optional 24-bit dual channel LVDS, CRT

Ethernet Interface

Chip	Intel 82562 PHY
Type	10Base-T / 100Base-TX auto-switching Fast Ethernet Full duplex, IEEE802.3U compliant

Audio Interface

Chip	Intel® ICH7M with Realtek® ALC655 AC97 Audio compliance
Interface	5.1 channels sound output Support Line-in, Line-out and MIC-in

Expansive Interface

PCI	4 PCI bus master interface
-----	----------------------------

Power and Environment

Power Requirement	5V, 5Vstandby
Dimension	114mm x 95mm
Temperature	Operating within 0 ~ 60° C (32 ~ 140° F) Storage within -20 ~ 85° C (-4 ~ 185° F)

Ordering Code

3311870A	Support Intel Core 2 Duo/Core Duo/Solo processor with onboard LVDS, Audio, SATA, USB2.0, LPT, PCI, FDD
3311870B	Same as Option A , but with Embedded Low Voltage Intel Core 2 Duo (L7500) 1.60 GHz Processor, FSB 800 MHz, with 4.0 MB L2 Cache
3311870C	Same as Option A , but with Embedded Low Voltage Intel Core 2 Duo (L7400) 1.50 GHz Processor, FSB 667 MHz, with 4.0 MB B2 Cache
3311870D	Same as Option A , but with Embedded Low Voltage Intel Core Duo (L2400) 1.55 GHz Processor, FSB 667 MHz, with 2.0 MB Cache
3311870E	Same as Option A , but with Embedded Ultra Low Voltage Intel Core Duo (U2500) 1.20 GHz Processor, FSB 533 MHz, with 2.0 MB C0 Cache
3311870F	Same as Option A , but with Embedded Ultra Low Voltage Intel Celeron M (423) 1.06 GHz Processor, FSB 533 MHz, with 1 MB C0 Cache

1. Specification may be different than actual production.

1.3 <Mechanical Drawing>

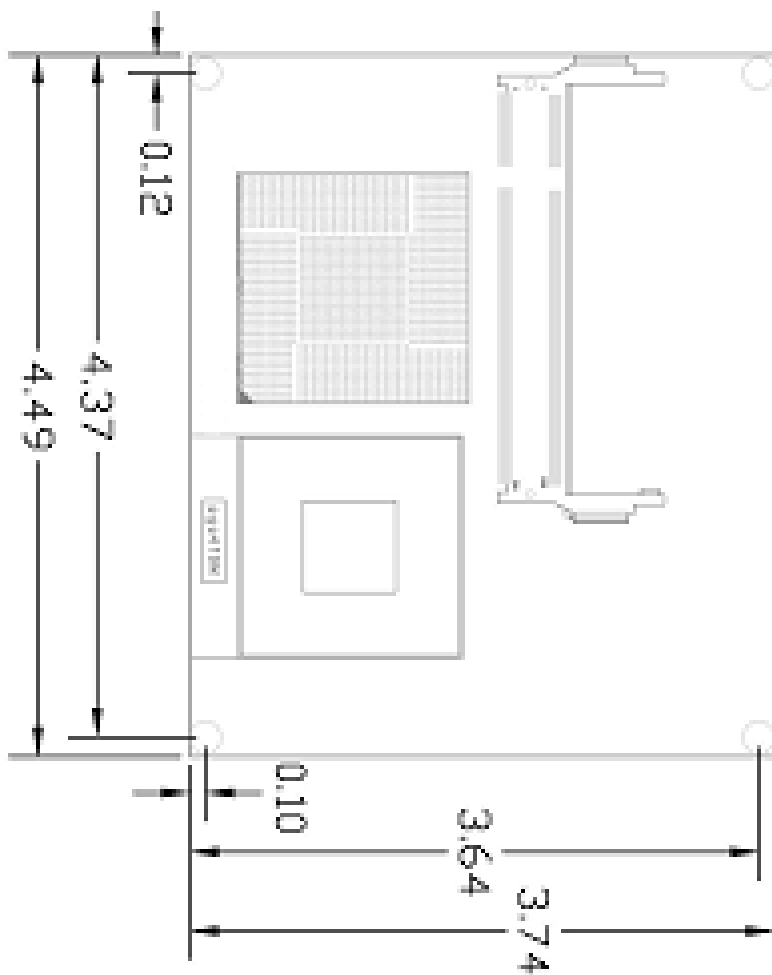

1.4 <Block Diagram>

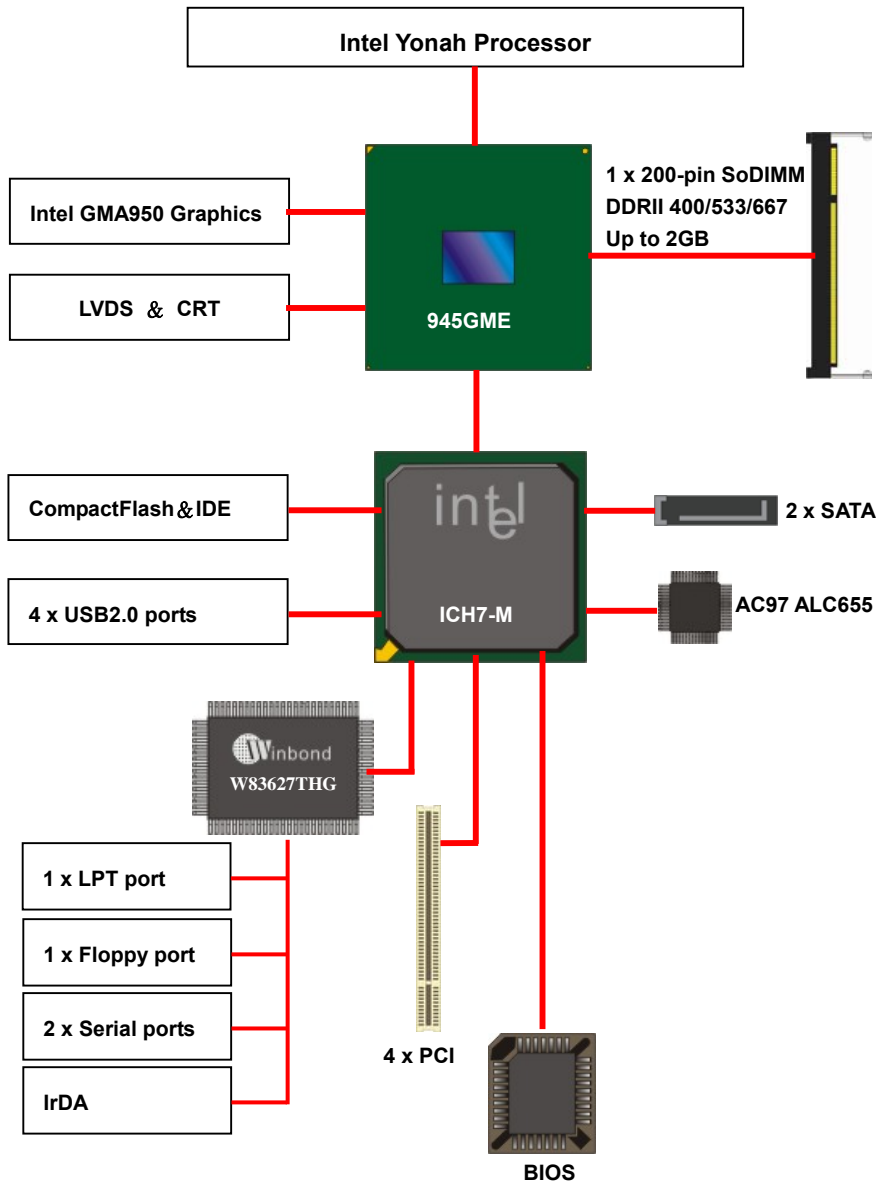

Chapter 2 <Hardware Setup>

2.1 <Connector Location>

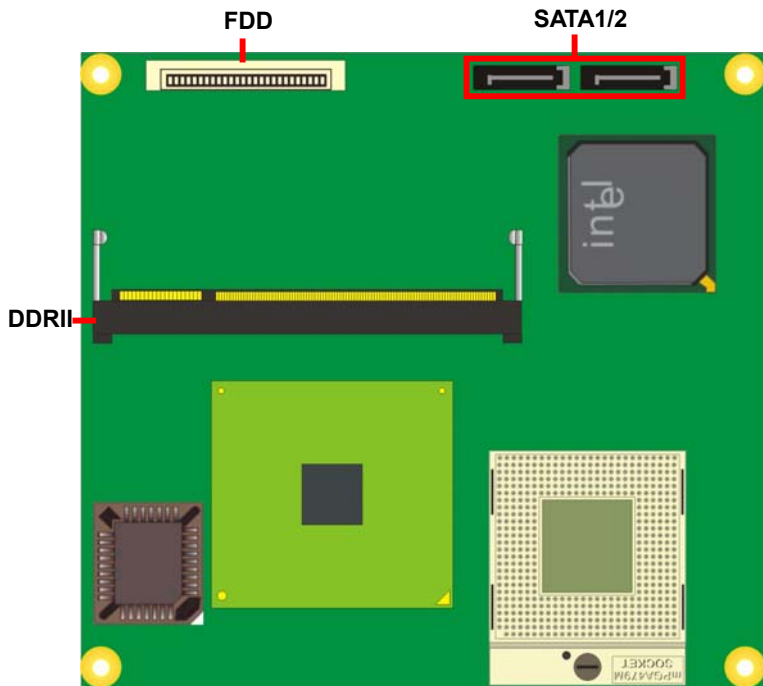

2.2 <Connector Reference>

2.2.1 <Internal Connector>

Connector	Function	Remark
DDRII	200-pin DDR2 SDRAM So-DIMM	Standard
FDD	26-pin slim type floppy connector	Slim
SATA1/2	7-pin Serial ATA connector	Standard

2.3 <CPU and Memory Setup>

2.3.1 < CPU >

The board comes with the socket479 for Intel Core 2 Duo/ Core Duo/Core Solo processors, it supports new generation of Intel Core Duo processors with 533/667MHz of front side bus and 2MB L2 cache. Please follow the instruction to install the CPU properly.

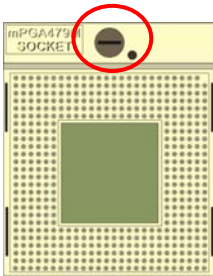

1. Use the flat-type screw drive to unlock the CPU socket

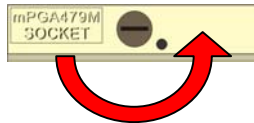

Unlock way

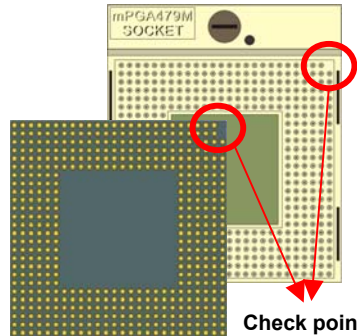

2. Follow the pin direction to install the processor on the socket

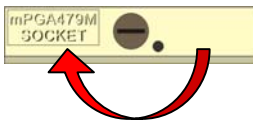

3. Lock the socket

2.3.2 <Memory>

The board supports one 200-pin DDRII So-DIMM SDRAM and up to 2GB of capacity, only non-ECC, unbuffered memory is supported.

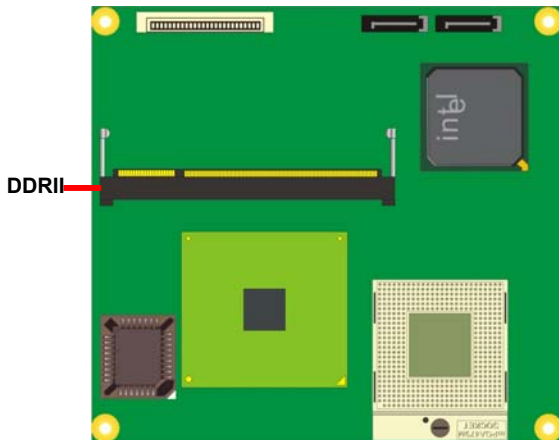

2.4 <Enhanced IDE Interface >

The module supports one enhanced IDE interface, dual channel for 2 ATAPI devices with ATA33/66/100.

2.5 <Serial ATA Interface>

Based on Intel ICH7-M, the board provides two Serial ATA interfaces with up to 150MB/s of transfer rate.

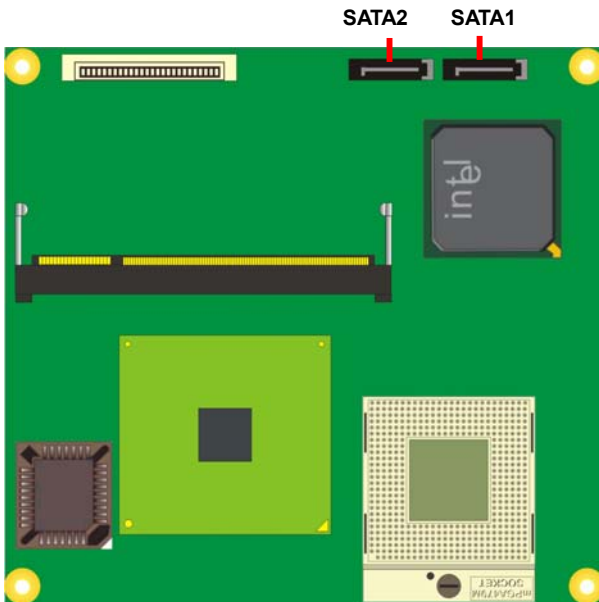

2.6 <Floppy Port>

The board provides a slim type floppy port; please use the 26-pin ribbon cable in the package to connect the floppy device.

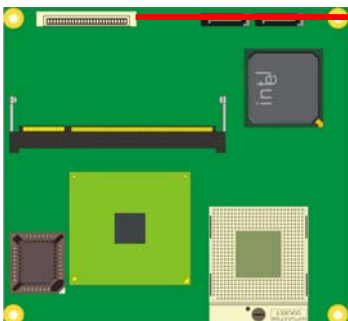
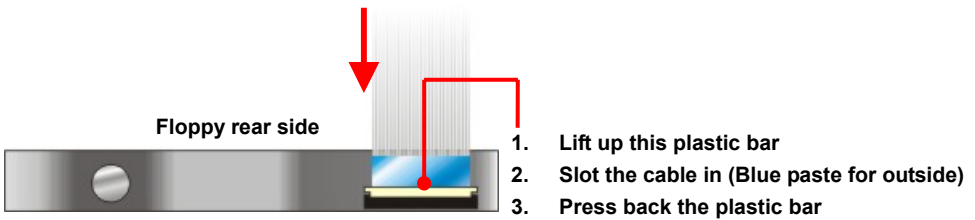
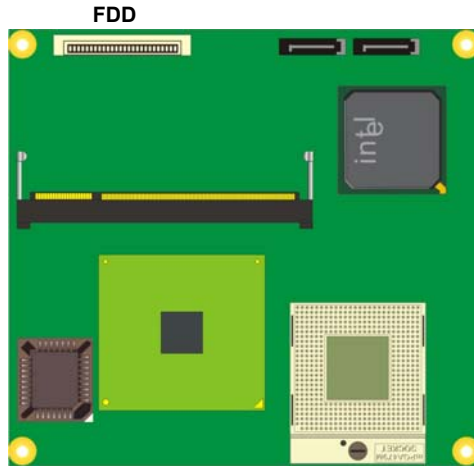

4. Lift up the brown plastic bar
5. Slot the cable in (Blue paste for brown bar side)
6. Press back the plastic bar

2.7 <LAN Interface>

The board provides 10/100Mbps LAN interfaces with Intel 82562GT PHY controller, and compliant with standard IEEE 802.3 Ethernet interface for 100BASE-TX.

2.8 <Onboard Display Interface>

Based on Intel 945GME chipset with built-in GMA (Graphic Media Accelerator) 950 graphics. The board provides dual display function with clone mode and extended desktop mode for CRT and LCD.

2.9<USB2.0 Interface>

Based on Intel ICH7-M, the board provides 4 USB2.0 ports. The USB2.0 interface provides up to 480Mbps of transferring rate.

Interface	USB2.0
Controller	Intel ICH7-M
Transfer Rate	Up to 480Mb/s

PS: The USB2.0 will be only active when you connecting with the USB2.0 devices, if you insert an USB1.1 device, the port will be changed to USB1.1 protocol automatically. The transferring rate of USB2.0 as 480Mbps is depending on device capacity, exact transferring rate may not be up to 480Mbps.

(This Page is Left For Blank)

Chapter 3 <System Configuration>

3.1 <Video Memory Setup>

Based on Intel® 945GME chipset with GMA (Graphic Media Accelerator) 950, the board supports Intel® DVMT (Dynamic Video Memory Technology) 3.0, which would allow the video memory to be allocated up to 224MB.

To support DVMT, you need to install the Intel GMA 950 Driver with supported OS.

BIOS Setup:

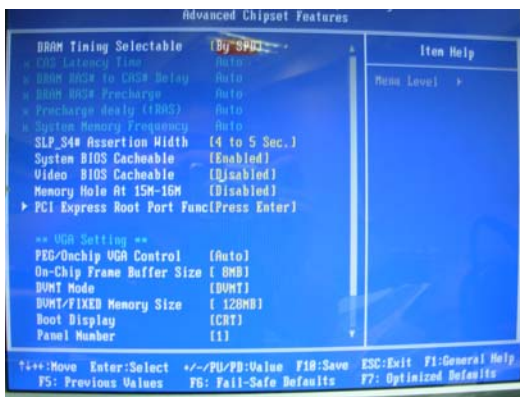

On-Chip Frame Buffer Size:

This item can let you select video memory which been allocated for legacy VGA and SVGA graphics support and compatibility. The available option is **1MB** and **8MB**.

Fixed + DVMT Memory Size:

You can select the fixed amount and the DVMT amount at the same time for a guaranteed video memory and additional dynamic video memory, please check the table below for available setting.

Notice:

1. The On-Chip Frame Buffer Size would be included in the Fixed Memory.

Please select the memory size according to this table.

SBIOS Options				System Memory
Pre-Allocated Memory	Fixed	DVMT	Fixed+DVMT	
1MB(1)	32MB	32MB	NA	128MB
8MB	32MB	32MB	NA	128MB
1MB(1)	64MB	64MB	NA	256MB
	128MB	128MB	64MB+64MB	256MB
8MB	64MB	64MB	NA	256MB
	128MB	128MB	64MB+64MB	256MB
1MB(1)	64MB	64MB	NA	512MB
	128MB	128MB	64MB+64MB	512MB
	NA	"Maximum DVMT"	NA	512MB
8MB	64MB	64MB	NA	512MB
	128MB	128MB	64MB+64MB	512MB
	NA	"Maximum DVMT"	NA	512MB

The panel type mapping is list below:

BIOS panel type selection form			
18 bits Single channel		24 bits Dual channel	
NO.	Output format	NO.	Output format
1	640 x 480	9	1024 x 768
2	800 x 600	10	1280 x 768
3	1024 x 768	11	1280 x 1024
24 bits Single channel		12	1366 x 768
4	1280 x 768	13	1400 x 1050 @ 108Mhz
5	1280 x 1024	15	1600 x 1200
6	1366 x 768		
7	1280 x 800		
8	1600 x 1200		
14	1024 x 768		

(This Page is Left for Blank)

Appendix A <ETX connector Assignment>

Connector A

A1	GND	A2	GND	A51	VCC	A52	VCC
A3	PCICLK3	A4	PCICLK4	A53	PAR	A54	-SERR
A5	GND	A6	GND	A55	-GPERR	A56	N/C
A7	PCICLK2	A8	PCICLK1	A57	-PME	A58	-USB2
A9	-REQ3	A10	-GNT3	A59	-LOCK	A60	-DEVSEL
A11	-GNT2	A12	+3.3V	A61	-TRDY	A62	-USB3
A13	-REQ2	A14	-GNT1	A63	-IRDY	A64	-STOP
A15	-REQ1	A16	+3.3V	A65	-FRAME	A66	-USB2
A17	-GNT0	A18	N/C	A67	GND	A68	GND
A19	VCC	A20	VCC	A69	AD16	A70	-CBE2
A21	SERIRQ	A22	-REQ0	A71	AD17	A72	+USB3
A23	AD0	A24	+3.3V	A73	AD19	A74	AD18
A25	AD1	A26	AD2	A75	AD20	A76	USB-
A27	AD4	A28	AD3	A77	AD22	A78	AD21
A29	AD6	A30	AD5	A79	AD23	A80	-USB1
A31	-CBE0	A32	AD7	A81	AD24	A82	-CBE3
A33	AD8	A34	AD9	A83	VCC	A84	VCC
A35	GND	A36	GND	A85	AD25	A86	AD26
A37	AD10	A38	AUXAL	A87	AD26	A88	+USB0
A39	AD11	A40	MIC	A89	AD27	A90	AD29
A41	AD12	A42	AUXAR	A91	AD30	A92	+USB1
A43	AD13	A44	N/C	A93	-PCIRST	A94	AD31
A45	AD14	A46	SNDL	A95	-INTRC	A96	-INTRD
A47	AD15	A48	ASGND	A97	-INTRA	A98	-INTRB
A49	-CBE1	A50	SNDR	A99	GND	A100	GND

Connector C

C1	GND	C2	GND	C51	LPT	C52	N/C
C3	AR	C4	AB	C53	VCC	C54	GND
C5	HSYNC	C6	AG	C55	-STB	C56	-AFD
C7	VSYNC	C8	DDCK	C57	N/C	C58	PD7
C9	-DETECT	C10	DDDA	C59	IRRX	C60	-ERR
C11	LCD16	C12	LCD18	C61	IRTX	C62	PD6
C13	LCD17	C14	LCD19	C63	RXD2	C64	-INIT
C15	GND	C16	GND	C65	GND	C66	GND
C17	LCD13	C18	LCD15	C67	-RTS2	C68	PD5
C19	LCD12	C20	LCD14	C69	-DTR2	C70	-SLIN
C21	GND	C22	GND	C71	-DCD2	C72	PD4
C23	LCD8	C24	LCD11	C73	-DSR2	C74	PD3
C25	LCD9	C26	LCD10	C75	-CTS2	C76	PD2
C27	GND	C28	GND	C77	TD2	C78	PD1
C29	LCD5	C30	LCD1	C79	-RI2	C80	PD0
C31	LCD4	C32	LCD0	C81	VCC	C82	VCC
C33	GND	C34	GND	C83	RD1	C84	-ACK
C35	LCD1	C36	LCD3	C85	-RTS1	C86	BUSY
C37	LCD0	C38	LCD2	C87	-DTR1	C88	PE
C39	VCC	C40	VCC	C89	-DCD1	C90	SLCT
C41	N/C	C42	N/C	C91	-DSR1	C92	MSCLK
C43	N/C	C44	INV_ON	C93	-CTS1	C94	MSDAT
C45	N/C	C46	AVDDCTL	C95	TD1	C96	KBCLK
C47	TV_DACA	C48	TV_DACB	C97	-RL1	C98	KBDATA
C49	N/C	C50	TV_DACC	C99	GND	C100	GND

Connector D

D1	GND	D2	GND	D51	N/C	D52	-PDIOR
D3	5V_SB	D4	PWRGD	D53	N/C	D54	-PDIOW
D5	PS_ON	D6	SYSPKR	D55	N/C	D56	PDDREQ
D7	PW_BN	D8	BATT	D57	N/C	D58	PDD15
D9	N/C	D10	LINK0	D59	N/C	D60	PDD0
D11	N/C	D12	ACTLCD0	D61	N/C	D62	PDD14
D13	N/C	D14	SPDLED0	D63	N/C	D64	PDD1
D15	N/C	D16	N/C	D65	GND	D66	GND
D17	VCC	D18	VCC	D67	N/C	D68	PDD13
D19	-OC0	D20	N/C	D69	N/C	D70	PDD2
D21	N/C	D22	N/C	D71	N/C	D72	PDD12
D23	SMBCLK	D24	SMBDATA	D73	N/C	D74	PDD3
D25	N/C	D26	N/C	D75	N/C	D76	PDD11
D27	N/C	D28	-SATA_LED	D77	N/C	D78	PDD4
D29	N/C	D30	-PCS3	D79	N/C	D80	PDD10
D31	N/C	D32	-PCS1	D81	VCC	D82	VCC
D33	GND	D34	GND	D83	N/C	D84	PDD5
D35	N/C	D36	PDA2	D85	N/C	D86	PDD9
D37	N/C	D38	PDA0	D87	N/C	D88	PDD6
D39	N/C	D40	PDA1	D89	-ICHRI	D90	66DET
D41	-BATLOW	D42	N/C	D91	RD-	D92	PDD8
D43	N/C	D44	IRQ14	D93	RD+	D94	N/C
D45	N/C	D46	PDDACK	D95	TD-	D96	PDD7
D47	N/C	D48	PDRDY	D97	TD+	D98	-IDERST
D49	VCC	D50	VCC	D99	GND	D100	GND

Appendix B <I/O Port Pin Assignment>

B.1 <Floppy Port>

Connector: **FDD**

Type: 26-pin connector



Pin	Description	Pin	Description
1	VCC	2	INDEX
3	VCC	4	DRV0
5	VCC	6	DSKCHG
7	DRV1	8	N/C
9	MTR1	10	MTR0
11	RPM	12	DIR
13	N/C	14	STEP
15	Ground	16	WRITE DATA
17	Ground	18	WRITE GATE
19	N/C	20	TRACK 0
21	N/C	22	WRPTR
23	Ground	24	RDATA-
25	Ground	26	SEL

B.2 <Serial ATA Port>

Connector: **SATA1/2**

Type: 7-pin wafer connector

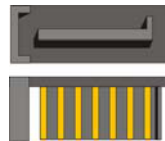

1	2	3	4	5	6	7
GND	RSATA_TXP1	RSATA_TXN1	GND	RSATA_RXN1	RSATA_RXP1	GND

(This Page is Left for Blank)

Appendix D <System Resources>

D1.<I/O Port Address Map>

[00000000 - 0000000F]	Direct memory access controller
[00000010 - 0000001F]	Motherboard resources
[00000020 - 00000021]	Programmable interrupt controller
[00000022 - 0000003F]	Motherboard resources
[00000040 - 00000043]	System timer
[00000044 - 0000005F]	Motherboard resources
[00000061 - 00000061]	System speaker
[00000062 - 00000063]	Motherboard resources
[00000065 - 0000006F]	Motherboard resources
[00000070 - 00000073]	System CMOS/real time clock
[00000074 - 0000007F]	Motherboard resources
[00000080 - 00000090]	Direct memory access controller
[00000091 - 00000093]	Motherboard resources
[00000094 - 0000009F]	Direct memory access controller
[000000A0 - 000000A1]	Programmable interrupt controller
[000000A2 - 000000BF]	Motherboard resources
[000000C0 - 000000DF]	Direct memory access controller
[000000E0 - 000000EF]	Motherboard resources
[000000F0 - 000000FF]	Numeric data processor
[000001F0 - 000001F7]	Primary IDE Channel
[00000200 - 00000200]	Standard Game Port
[00000201 - 00000207]	Standard Game Port
[00000274 - 00000277]	ISAPNP Read Data Port
[00000279 - 00000279]	ISAPNP Read Data Port
[000002F8 - 000002FF]	Communications Port (COM2)
[00000378 - 0000037F]	Printer Port (LPT1)
[00000380 - 0000038B]	Mobile Intel(R) 945GM Express Chipset Family
[000003C0 - 000003DF]	Mobile Intel(R) 945GM Express Chipset Family
[000003F0 - 000003F5]	Standard floppy disk controller
[000003F6 - 000003F6]	Primary IDE Channel
[000003F7 - 000003F7]	Standard floppy disk controller
[000003F8 - 000003FF]	Communications Port (COM1)
[00000400 - 000004BF]	Motherboard resources
[000004D0 - 000004D1]	Motherboard resources
[00000500 - 0000051F]	Intel(R) 82801G (ICH7 Family) SMBus Controller - 27DA
[00000778 - 00000778]	Printer Port (LPT1)
[00000800 - 0000087F]	Motherboard resources
[00000880 - 0000088F]	Motherboard resources
[00000A79 - 00000A79]	ISAPNP Read Data Port

D2.<Memory Address Map>

[00000000 - 0009FFFF]	System board
[000A0000 - 000BFFFF]	PCI bus
[000A0000 - 000BFFFF]	Mobile Intel(R) 945GM Express Chipset Family
[000C0000 - 000DFFFF]	PCI bus
[000E0000 - 000EFFFF]	System board
[000F0000 - 000F7FFF]	System board
[000F8000 - 000FBFFF]	System board
[000FC000 - 000FFFFF]	System board
[00100000 - 3F6DFFFF]	System board
[3F6E0000 - 3F6FFFFF]	System board
[3F700000 - FEBFFFFF]	PCI bus
[00636500 - 00D1CCFF]	System board
[3F6E0000 - 3F6FFFFF]	System board
[3F700000 - FEBFFFFF]	PCI bus
[D0000000 - DFFFFFFF]	Mobile Intel(R) 945GM Express Chipset Family
[E0000000 - EFFFFFFF]	Motherboard resources
[FDEF0000 - FDEF0FFF]	Intel(R) PRO/100 VE Network Connection
[FDEF0000 - FDEF0FFF]	Realtek RTL8139 Family PCI Fast Ethernet NIC
[FDF00000 - FDF7FFFF]	Mobile Intel(R) 945GM Express Chipset Family
[FDF80000 - FDFBFFFF]	Mobile Intel(R) 945GM Express Chipset Family
[FDFFD000 - FDFFD0FF]	Realtek AC'97 Audio
[FDFFE000 - FDFFE1FF]	Realtek AC'97 Audio
[FDFFF000 - FDFFF3FF]	Intel(R) 82801G (ICH7 Family) USB2 Enhanced Host Controller - 27CC
[FEB80000 - FEBFFFFF]	Mobile Intel(R) 945GM Express Chipset Family
[FEC00000 - FEC00FFF]	System board
[FED13000 - FED1DFFF]	System board
[FED20000 - FED8FFFF]	System board
[FEE00000 - FEE00FFF]	System board
[FFB00000 - FFB7FFFF]	System board
[FFB80000 - FFBFFFFF]	Intel(R) 82802 Firmware Hub Device
[FFF00000 - FFFFFFFF]	System board

D3.<System IRQ Resources>

- (ISA) 0 System timer
- (ISA) 3 Communications Port (COM2)
- (ISA) 4 Communications Port (COM1)
- (ISA) 6 Standard floppy disk controller
- (ISA) 8 System CMOS/real time clock
- (ISA) 9 Microsoft ACPI-Compliant System
- (ISA) 13 Numeric data processor
- (ISA) 14 Primary IDE Channel
- (PCI) 15 Intel(R) 82801G (ICH7 Family) SMBus Controller - 27DA
- (PCI) 16 Intel(R) 82801G (ICH7 Family) USB Universal Host Controller - 27CB
- (PCI) 16 Mobile Intel(R) 945GM Express Chipset Family
- (PCI) 17 Realtek AC'97 Audio
- (PCI) 18 Intel(R) 82801G (ICH7 Family) USB Universal Host Controller - 27CA
- (PCI) 18 Realtek RTL8139 Family PCI Fast Ethernet NIC
- (PCI) 19 Intel(R) 82801G (ICH7 Family) USB Universal Host Controller - 27C9
- (PCI) 20 Intel(R) PRO/100 VE Network Connection
- (PCI) 23 Intel(R) 82801G (ICH7 Family) USB Universal Host Controller - 27C8
- (PCI) 23 Intel(R) 82801G (ICH7 Family) USB2 Enhanced Host Controller - 27CC

(This Page is Left for Blank)

Any advice or comments about our products and service, or anything we can help you with please don't hesitate to contact with us. We will do our best to support your products, projects and business.



Address: Global American, Inc.
17 Hampshire Drive
Hudson, NH 03051

Telephone: Toll Free U.S. Only (800) 833-8999
(603) 886-3900

FAX: (603) 886-4545

Website: <http://www.globalamericaninc.com>

Support: Technical Support at Global American