



integration with integrity

User's Manual

Single Board Computer 3308260

Version 1.0 , March 2009



Copyrights

This manual is copyrighted and all rights are reserved. It does not allow any non authorization in copied, photocopied, translated or reproduced to any electronic or machine readable form in whole or in part without prior written consent from the manufacturer.

In general, the manufacturer will not be liable for any direct, indirect, special, incidental or consequential damages arising from the use of inability to use the product or documentation, even if advised of the possibility of such damages. The manufacturer keeps the rights in the subject to change the contents of this manual without prior notices in order to improve the function design, performance, quality and reliability. The author assumes no responsibility for any errors or omissions, which may appear in this manual, nor does it make a commitment to update the information contained herein.

Trademarks

Intel is a registered trademark of Intel Corporation.

Award is a registered trademark of Award Software, Inc.

All other trademarks, products and or product's name mentioned herein are mentioned for identification purposes only, and may be trademarks and/or registered trademarks of their respective companies or owners.

Chapter 1

Introduction

1.7 Packing List



1 x 3308260 3.5" Embedded Board



1 x Driver CD



1 x Quick Installation Guide

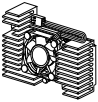

1 x CPU Cooler
90 x 66 x 27.8mm (L x W x H)



1 x ATX Power cable
ATX main power connector (2x10 pins)
power connector (2x5 pins)

If any of the above items is damaged or missing, contact your vendor immediately.

1.9 Specifications

Form Factor	3.5" Embedded Board
CPU	mPGA 478 Socket for Intel® Core™ 2 Duo Processor, up to FSB 800MHz
Chipset	Intel® GME965 + Intel® ICH8M
System Memory	1 x 200-pin SO-DIMM socket Up to 2GB DDR II 533/667MHz SDRAM
VGA/ LCD Controller	Mobile Intel® Graphics Media Accelerator (GMA) X3100 graphics core w/ CRT/ LVDS 24-bit dual Channel
Ethernet	2 x Realtek 8111B PCIe 10/100/1000 Base-T Fast Ethernet LAN
I/O Chips	Winbond W83627HG
BIOS	AMI PnP Flash BIOS
Audio	Realtek ALC888 HD Codec, MIC-in/Line-in/Line-out
Serial ATA	2 x Serial ATA 300MB/s HDD transfer rate
IDE Interface	1 x IDE (Ultra ATA 33), support 2 IDE devices
Serial Port	2 x COM port (COM1: RS-232; COM2: RS-232/422/485)
Parallel Port/ Floppy	1 x LPT Port (SPP/EPP/ECP mode selectable) 1 x Floppy connector share with LPT port
IrDA	1 x IrDA connector
KBMS	Standard PS/2 Keyboard and Mouse
Universal Serial Bus	6 x USB 2.0 compliant
DIO	8-bit programmable Digital I/O
Expansion Interface	1 x CF II Socket (Share with IDE) 1 x Mini PCI Socket
Hardware Monitor Chip	Integrated in W83627HG
Operation Temp.	-40°C ~ +85°C (-40°F ~ 185°F)
Watchdog Timer	255-level Reset
Dimension (L x W)	146 x 102 mm (5.7 " x 4.0 ")

1.10 Board Dimensions

Layout Top View

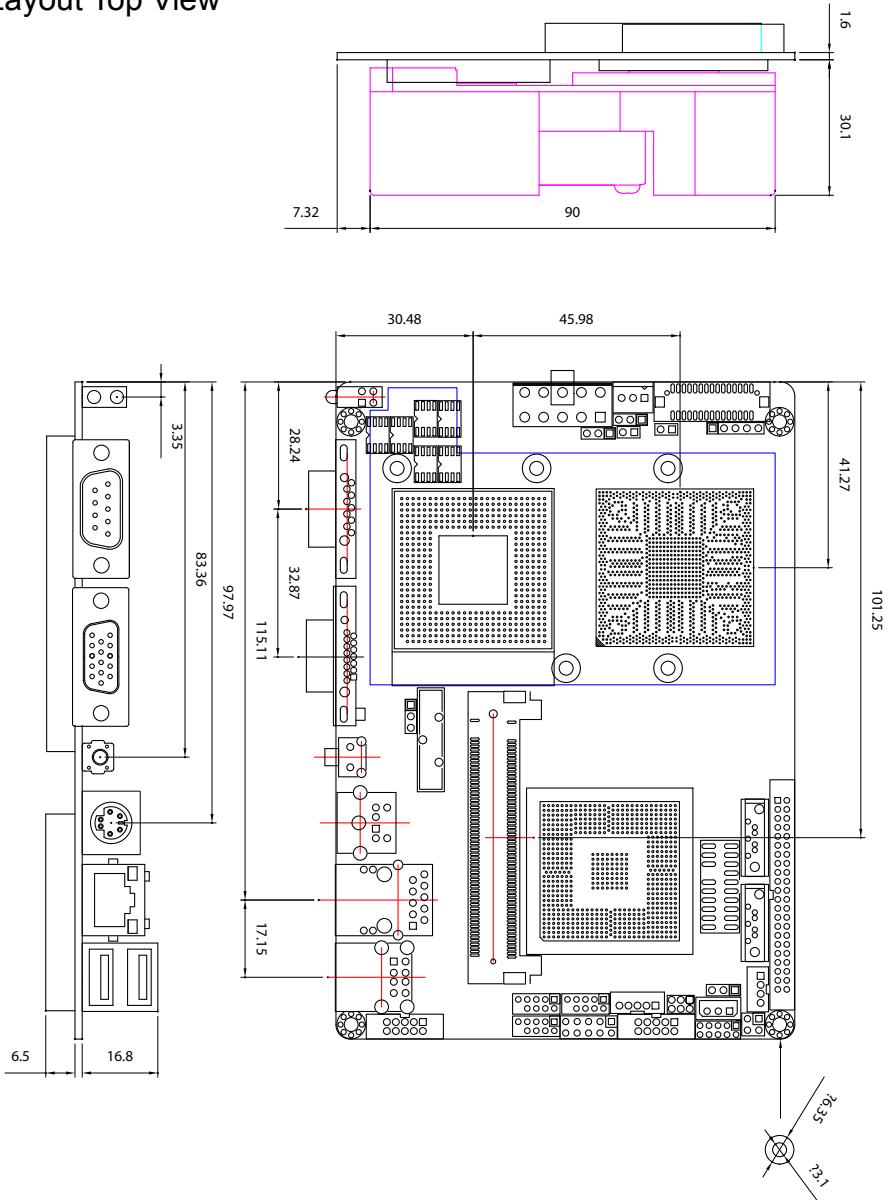

Unit:mm

Layout Bottom View

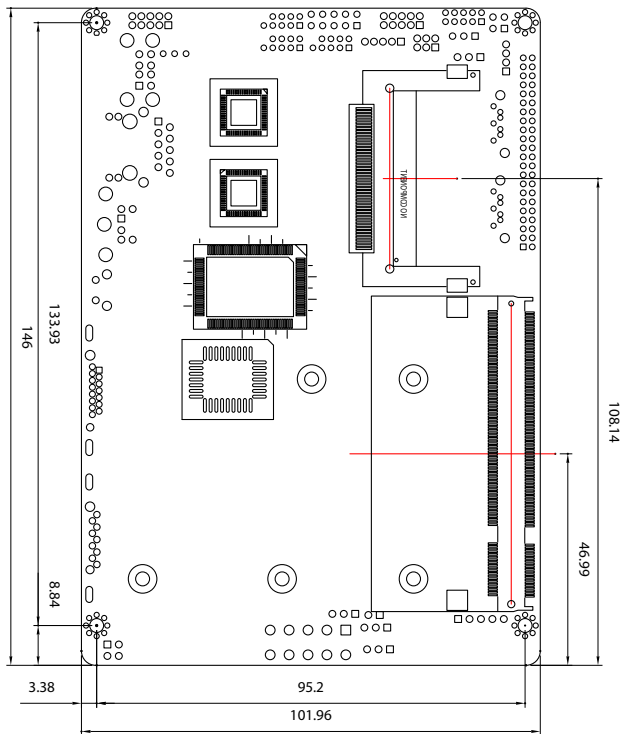

Unit:mm

1.11 Installing the CPU

The processor socket comes with a screw to secure the CPU. As showing in the picture as bellow, loose the screw first before inserting the CPU.

Place the CPU into the socket by making sure the notch on the corner of the CPU corresponding with the notch on the inside of the socket. Once the CPU has slide into the socket, lock the screw.

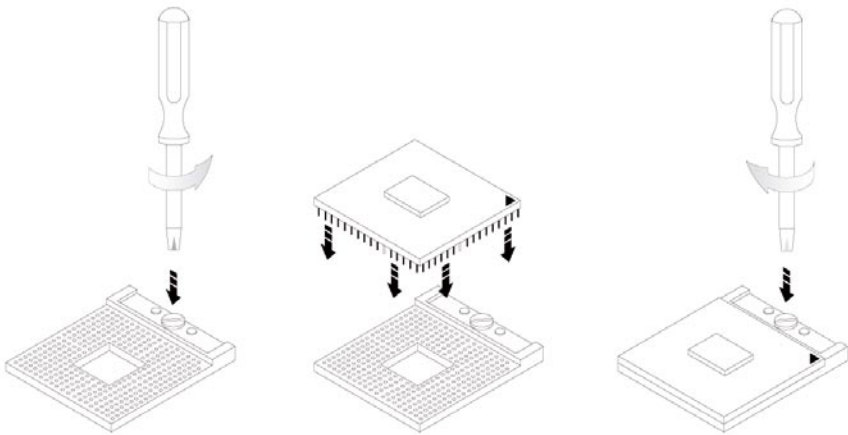

Make sure that heat sink of the CPU top surface is in complete contact to avoid the CPU overheating problem.

If not, it would cause your system or CPU to be hanged, unstable, damaged.

1.12 Installing the Memory

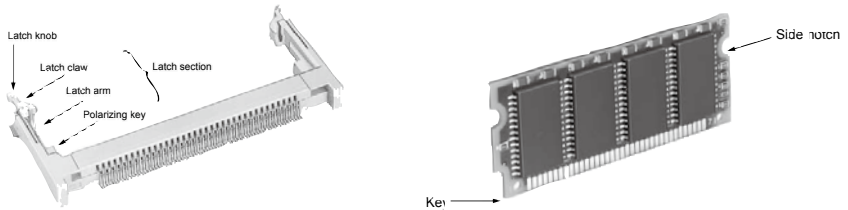

To install the Memory module, locate the Memory SO-DIMM slot on the board and perform as below:

1. Adjust the socket polarizing key and the board key to the same direction.
2. Insert the board obliquely. Moreover, lay the board in parallel to the opening at angle of 20° to 30° , and softly insert the board so as to hit the socket bottom. Stopping insertion halfway will result in improper insertion.
3. Applying the board side notch in parallel to the socket bottom so that the board position cannot be displaced, press the board side notch up, and fix it to the latch portion at both socket edges. Press the board side notch, and release the notch with a snap “click” tone, if the printed board exceeds the latch claw head.

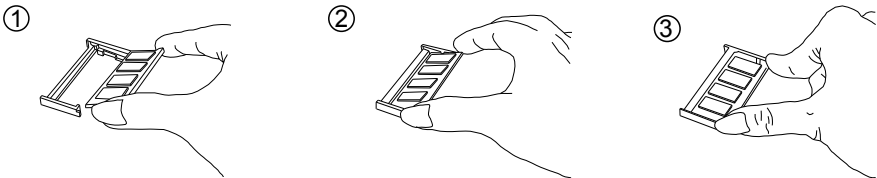

Procedures for board extraction

Apply the thumb nail to the latch knob at both socket edges. Forcibly widen the latch knobs to right and left ways, and release the latch. Then draw the board out along an angle where the board is raised.

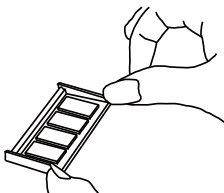

1.13 Heatsink Installation

1. Put the heatsink on 3308260, and screw it on in the direction of the board. Insert four screws (No. 1) downward into the holes and turn them tightly.
2. Verify the direction is correct (No. 2) and plug the FAN connector into CPUF1 connector.

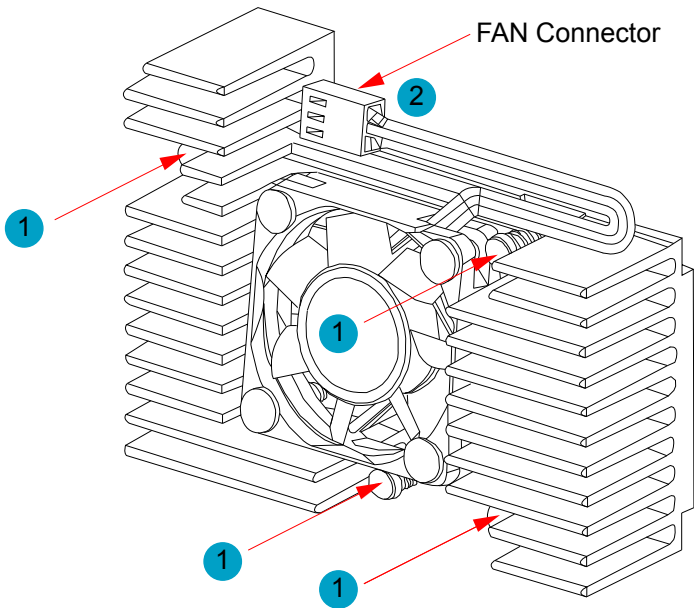

1.14 Heatsink Dimensions

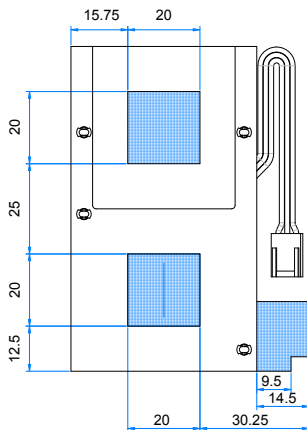
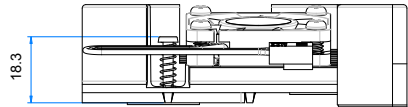
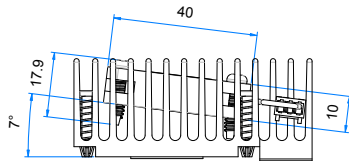
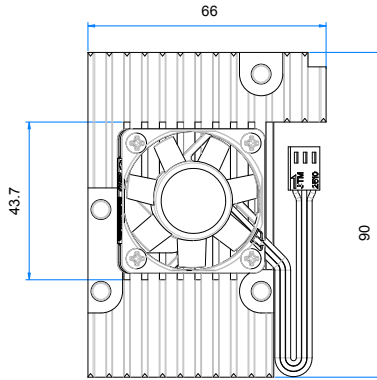

Chapter 2

Installation

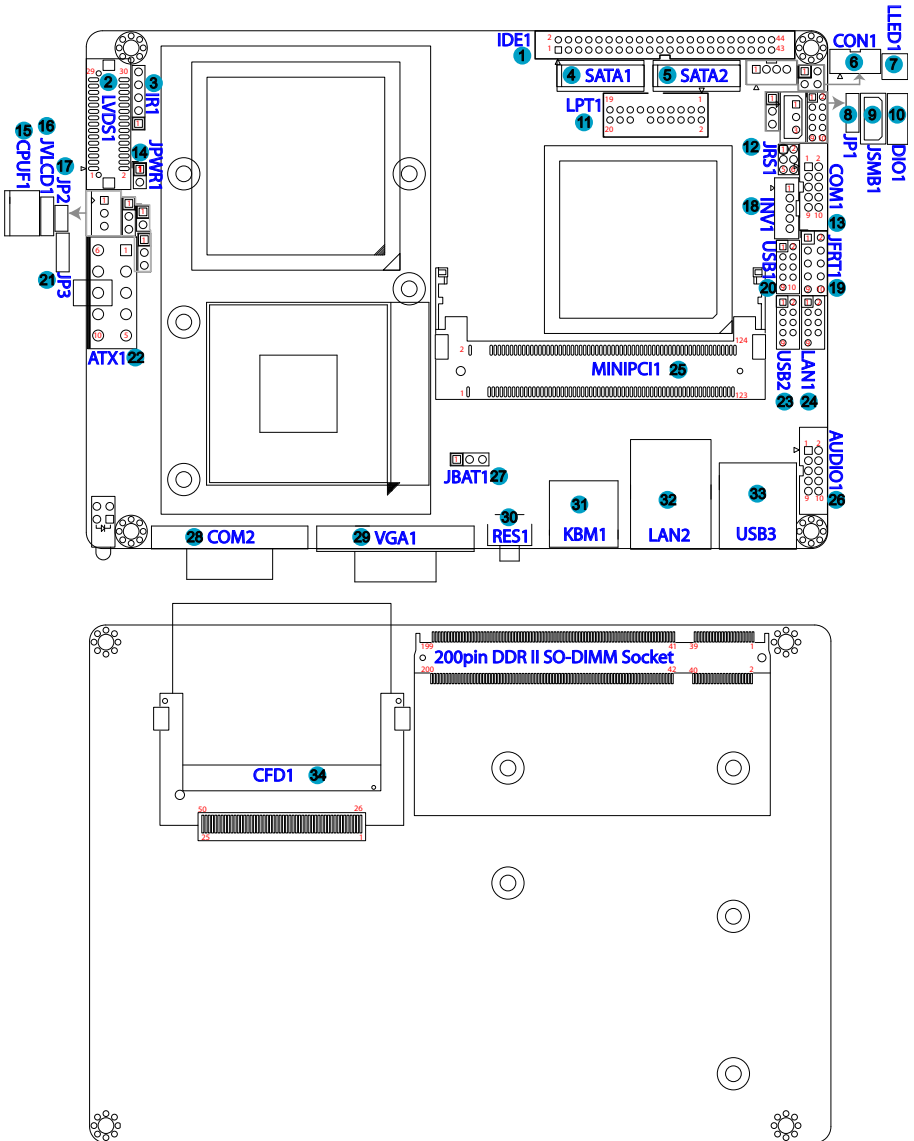

2.2 Jumpers and Connectors



Jumpers

JP1, JP3: COM Port Power Special Support (8), (21)

Connector type: 2.54mm pitch 1x3 pin header.



Pin	Voltage	
1-2	Standard Signal for Pin-9 (default)	
2-3	+12V	

JRS1: COM2 RS-232/422/485 Mode Select (12)

The onboard COM2 port can be configured to operate in RS-422 or RS-485 modes. RS-422 modes differ in the way RX/TX is being handled. Jumper JRS1 switches between RS-232 or RS-422/485 mode. When JRS1 is set to RS-422 or RS-485 mode, there will be only +12V output let while JRS1 is set. All RS-232/422/482 modes are available on COM2.



It can be configured COM2 to operate in RS-232, RS-422 or RS-485 mode
Connector type: 2.00mm pitch 2x3 pin header.

Mode	RS-232 (Default)	RS-422	RS-485
1-2	Short	Open	Open
3-4	Open	Short	Open
5-6	Open	Open	Short

		
---	---	---

JPWR1: AT/ATX Power Mode (14)

Connector type: 2.54mm pitch 1x2 pin header.

Pin 1-2	Mode	
Short	AT Mode	
Open	ATX Mode (Default)	

JVLCD1: LCD Panel Voltage Select (16)

The voltage of LCD panel could be selected by JVLCD1 in +5V or +3.3V.

Connector type: 2.54 mm pitch 1x3 pin header

Pin Voltage

1-2 +5V



2-3 +3.3V (Default)



JP2: Compact Flash Select (17)

Connector type: 2.54mm pitch 1x2 pin header.

Pin 1-2 Function Select

Short Master



Open Slave (Default)



JBAT1: Clear CMOS Setup (27)

If the board refuses to boot due to inappropriate CMOS settings here is how to proceed to clear (reset) the CMOS to its default values.

Connector type: 2.54mm pitch 1x3 pin header

Pin **Mode**

1-2 Keep CMOS (Default)



2-3 Clear CMOS



You may need to clear the CMOS if your system cannot boot up because you forgot your password, the CPU clock setup is incorrect, or the CMOS settings need to be reset to default values after the system BIOS has been updated.

Refer to the following solutions to reset your CMOS setting:

Solution A:

1. Power off the system and disconnect the power cable.
2. Place a shunt to short pin 1 and pin 2 of JBAT1 for five seconds.
3. Place the shunt back to pin 2 and pin 3 of JBAT1.
4. Power on the system.

Solution B:

If the CPU Clock setup is incorrect, you may not be able to boot up. In this case, follow these instructions:

1. Turn the system off, then on again. The CPU will automatically boot up using standard parameters.
2. As the system boots, enter BIOS and set up the CPU clock.

Note:

If you are unable to enter BIOS setup, turn the system on and off a few times.

Connectors

IDE1: IDE Connector (1)

An IDE drive ribbon cable has two connectors to support two IDE devices. If a ribbon cable connects to two IDE drives at the same time, one of them has to be configured as Master and the other has to be configured as Slave by setting the drive select jumpers on the drive.

Consult the documentation that came with your IDE drive for details on jumper locations and settings. You must orient the cable connector so that the pin 1 (color) edge of the cable corresponds to pin 1 of the IDE connector.

Connector type: 2.00mm pitch 2x22 pin header

Pin	Description	Pin	Description
1	IDE RESET	2	GND
3	DATA7	4	DATA8
5	DATA6	6	DATA9
7	DATA5	8	DATA10
9	DATA4	10	DATA11
11	DATA3	12	DATA12
13	DATA2	14	DATA13
15	DATA1	16	DATA14
17	DATA0	18	DATA15
19	GND	20	N/C (Key)
21	REQ	22	GND
23	IO WRITE	24	GND
25	IO READ	26	GND
27	IO READY	28	IDSEL
29	DACK	30	GND
31	IRQ14	32	N/C
33	ADAD1	34	ATA66 DETECT
35	ADAD0	36	ADAD2
37	CS#1	38	CS#3
39	IDEACTP	40	GND
41	+5V	42	+5V
43	GND	44	N/C

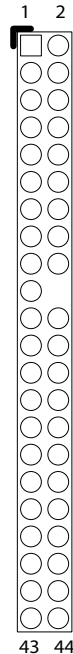

LVDS1: LVDS LCD Connector (2)

The LVDS connector supports 24-bit or 48-bit LVDS. VDD could be selected by JVLCD1 in +5V or +3.3V. Connector type: DF-13-30DP-1.25V

Pin	Description	Pin	Description
2	VDD	1	VDD
4	TX2CLK+	3	TX1CLK+
6	TX2CLK-	5	TX1CLK-
8	GND	7	GND
10	TX2D0+	9	TX1D0+
12	TX2D0-	11	TX1D0-
14	GND	13	GND
16	TX2D1+	15	TX1D1+
18	TX2D1-	17	TX1D1-
20	GND	19	GND
22	TX2D2+	21	TX1D2+
24	TX2D2-	23	TX1D2-
26	GND	25	GND
28	TX2D3+	27	TX1D3+
30	TX2D3-	29	TX1D3-

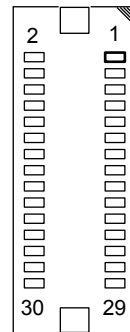

IR1: Infrared Connector (3)

Connector type: 2.54mm pitch 1x5 pin header

Pin	Voltage
1	+5V
2	N/C
3	IRRX
4	GND
5	IRTX

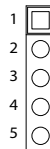

The IR connector can be configured to support wireless infrared module, user can transfer files to or from notebooks, PDA and printers.

Install infrared module onto IrDA connector and enable infrared function from BIOS setup and make sure to have correct orientation when you plug onto IrDA connector.

SATA1, 2: Serial ATA Connectors (4), (5)

The CPU board on board supports two SATA II connectors, second generation SATA drives transfer data at speeds as high as 300MB/s, twice the transfer speed of first generation SATA drives. The SATA drives can be configured in a RAID 0, RAID 1 or RAID 10 configuration.

Pin	Description
1	GND
2	TX+
3	TX-
4	GND
5	RX-
6	RX+
7	GND

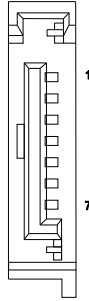

CON1: RS-422/ 485 Output Connector (6)

Connector type: 2.00mm pitch 1x4 box wafer connector

Pin	RS-422	RS-485
1	TX+	DATA+
2	TX-	DATA-
3	RX+	N/C
4	RX-	N/C



LLED1: LAN1 LED Indicator (7)

Connector type: 2.54mm pitch 2x2 pin header

Pin	Description	Pin	Description
1	LAN_Y-	2	LAN_Y+
3	LAN_G-	4	LAN_G+

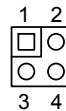

SMBUS1: External SMBUS Connector (9)

Connector type: 2.54mm pitch 1x3 box wafer connector.

Pin	Description
1	Data
2	Clock
3	GND



DIO1: Digital I/O Connector (10)

DIO1 is a 8-bit DIO connector that supports 4-bit In/ 4-bit Out.

Connector type: 2.00 mm pitch 2x5 pin header

Pin	Description	Pin	Description
1	DIO1	2	DIO2
3	DIO3	4	DIO4
5	DIO5	6	DIO6
7	DIO7	8	DIO8
9	+5V	10	GND



LPT1: Parallel Port Connector (11)

Connector type: 2.00mm pitch 2x10 pin header.

Pin	Description	Pin	Description
1	STROBE#	2	AFD#
3	PTD0	4	Error#
5	PTD1	6	INIT#
7	PTD2	8	SLIN#
9	PTD3	10	GND
11	PTD4	12	GND
13	PTD5	14	N/C (Key)
15	PTD6	16	Busy
17	PTD7	18	PE
19	ACK#	20	Select

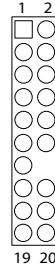

LPT1 can be configured as a connector floppy disk drive (FDD) interface through BIOS setup.

Pin	Description	Pin	Description
1	N/C	2	RWC#
3	RINDEX#	4	HEAD#
5	TRACK0#	6	DIR#
7	WP#	8	STEP#
9	RDATA#	10	GND
11	DSKCHG#	12	GND
13	N/C	14	N/C (Ke)
15	N/C	16	MOB#
17	N/C	18	WD#
19	DSB#	20	WE#

BIOS Setup

The default is to set LPT1 as FDD connector. To change the value, get into BIOS setup --> Integrated Peripheral --> Super IO Device.

BIOS Option	Setting	Description
External FDD Controller	Enabled	Set as FDD connector
Onboard Parallel Port	Disabled	
External FDD Controller	Disabled	
Onboard Parallel Port	378/IRQ7	Set as Parallel Port

COM1: RS-232 Connector (13)

Connector type: 2.00mm pitch 2x5 pin header.

Pin	Description	Pin	Description
1	DCD#	2	RXD
3	TXD	4	DTR#
5	GND	6	DSR#
7	RTS#	8	CTS#
9	RI#	10	N/C



CPUF1: CPU Fan Power Connector (15)

CPUF1 is 3-pin header for the system fan. The fan must be a +12V fan.

Pin	Description
1	GND
2	+12V
3	FAN_Detect



INV1: LCD Inverter Connector (18)

Connector type: 2.00mm pitch 1x5-pin box wafer connector.

Pin	Description
1	+12V
2	GND
3	Backlight on/off
4	Brightness control
5	GND



JFRT1: Switches and Indicators (19)

It provides connectors for system indicators that provides light indication of the computer activities and switches to change the computer status.

Connector type: 2.54 mm pitch 2x5 pin header

Pin	Description	Pin	Description
1	RESET+	2	RESET-
3	POWER LED+	4	POWER LED-
5	HDD LED+	6	HDD LED-
7	SPEAKER+	8	SPEAKER-
9	PSON+	10	PSON-



RES: Reset Button, pin 1-2.

This 2-pin connector connects to the case-mounted reset switch and is used to reboot the system.

PLED: Power LED Connector, pin 3-4.

This 2-pin connector connects to the case-mounted power LED. Power LED can be indicated when the CPU card is on or off. And keyboard lock can be used to disable the keyboard function so the PC will not respond by any input.

HLED: HDD LED Connector, pin 5-6.

This 2-pin connector connects to the case-mounted HDD LED to indicate hard disk activity.

SPK: External Speaker, pin 7-8.

This 2-pin connector connects to the case-mounted speaker.

PWRBTN: ATX soft power switch, pin 9-10.

This 2-pin connector connects to the case-mounted Power button.

USB1/ USB2: USB Connector (20), (23)

Connector type: 2.00mm pitch 2x5 pin header.

USB1/ USB2 supports two USB 2.0 w/ 480MB/s by pin header

Pin	Description	Pin	Description
1	+5V	2	+5V
3	USBD-	4	USBD-
5	USBD+	6	USBD+
7	GND	8	GND
9	GND	10	N/C (Key)

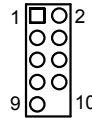

ATX1: ATX Power Supply Connector (22)

The ATX power supply has a single lead connector with a clip on one side of the plastic housing. There is only one way to plug the lead into the ATX power connector. Press the lead connector down until the clip snaps into place and secures the lead onto the connector.

Pin	Description	Pin	Description
6	5VSB	1	PS-ON
7	+5V	2	GND
8	+5V	3	GND
9	-12V	4	+12V
10	GND	5	+3.3V

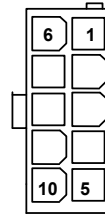

Warning

Incorrect installation of the power supply could result in serious damage to the mainboard and connected peripherals. Make sure the power supply is unplugged from the AC outlet before connecting the leads from the power supply.

LAN1: Fast Ethernet Connector (24)

Connector type: 2.0mm pitch 2x5 pin header

Pin	Description	Pin	Description
1	TX_MDI0+	2	TX_MDI0-
3	RX_MDI1+	4	MDI2+
5	MDI2-	6	RX_MDI1-
7	MDI3+	8	MDI3-
9	N/C	10	N/C (Key)

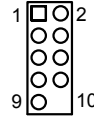

MINIPCI1: MiniPCI slot (25)



AUDIO1: Front Panel AUDIO Connector (26)

Connect a tape player or another audio source to the light blue Line-in connector to record audio on your computer or to play audio through your computer's sound chip and speakers.

Connect a micro-phone to the pink microphone connector to record audio to your computer.

Connector type: 2.00mm pitch 2x5 pin header.

Pin	Description	Pin	Description
1	Line-in Left	2	Line-in Right
3	GND	4	GND
5	MIC1	6	MIC2
7	GND	8	GND
9	Line-out Left	10	Line-out Right



COM2: RS-232 Connector (28)

Connector type: D-Sub 9-pin male.

Pin	Description	Pin	Description
6	DSR#	1	DCD#
7	RTS#	2	RXD
8	CTS#	3	TXD
9	RI#	4	DTR#
		5	GND

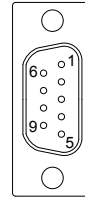
**VGA1: CRT Connector (29)**

Connector type: D-Sub 15-pin female.

Pin	Description	Pin	Description
1	RED	9	N/C
2	GREEN	10	GND
3	BLUE	11	N/C
4	N/C	12	VDDAT
5	GND	13	HSYNC
6	GND	14	VSYNC
7	GND	15	VDCLK
8	GND		

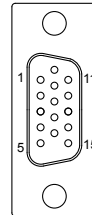
**RES1: Reset Switch (30)**

KBM1: Keyboard & Mouse (31)

Mini-Din Keyboard & Mouse connector

Pin	Description
1	KB Data
2	MS Data
3	GND
4	+5V
5	KB Clock
6	MS Clock

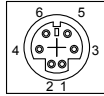

Note: KBM1 supports PS/2 keyboard directly, and PS/2 mouse supported with the additional PS/2 1-to-2 cable in standard packing.

LAN2: 10/100/1000 RJ-45 (32)

LAN2 supports 10/100/100 Mbps Fast Ethernet

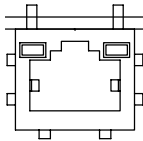

LAN2

USB3: Double Stack USB Type A Connector (33)

Connector type: double stack USB type A connector.

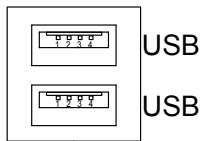

CFD1: Compact Flash II Socket (34)

Connector type: 50-pin compact flash connector

Pin	Description	Pin	Description
1	GND	26	CF_Detect
2	PDD3	27	PDD11
3	PDD4	28	PDD12
4	PDD5	29	PDD13
5	PDD6	30	PDD14
6	PDD7	31	PDD15
7	PDCS1#	32	PDCS3#
8	GND	33	N/C
9	GND	34	PDIOR#
10	GND	35	PDIOW#
11	GND	36	+5V
12	GND	37	PIDEIRQ
13	+5V	38	+5V
14	GND	39	CSEL#
15	GND	40	N/C
16	GND	41	IDERST#
17	GND	42	PIORDY
18	PDA2	43	PDDREQ
19	PDA1	44	PDDACK#
20	PDA0	45	HD_LED1#
21	PD0	46	PDIAG#
22	PD1	47	PDD8
23	PD2	48	PDD9
24	N/C	49	PDD10
25	N/C	50	GND

The interface of Compact Flash socket is designated to use IDE1.

Installation instructions

1. Compact Flash (CF) card is “not hot-swap”. If the CF card is swapped in the condition of system power-on, it will damage the CF card.
2. Make sure the Single Board Computer is powered OFF.
3. Plug the Compact Flash Type II device into its socket. Verify the direction is correct.
4. Power up the system.

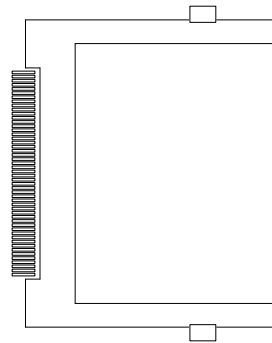

2.3 The Installation Paths of CD Driver

Driver	Path
CHIPSET	\CHIPSET\INTEL\INF 8.1
VGA	\GRAPHICS\INTEL_2K_XP_32\1431
LAN	\ETHERNET\REALTEK\811B_WIN5640
AUDIO	\AUDIO\REALTEK_HD\WINDOWS_R178

Chapter 4

Appendix

4.1 I/O Port Address Map

Each peripheral device in the system is assigned a set of I/O port addresses which also becomes the identity of the device.

The following table lists the I/O port addresses used.

Address	Device Description
00000000 - 0000000F	DMA Controller
00000080 - 0000009F	DMA Controller
000000C0 - 000000DF	DMA Controller
00000020 - 00000021	Programmable Interrupt Controller
000000A0 - 000000A1	Programmable Interrupt Controller
00000040 - 00000043	System Timer
00000044 - 00000047	System Timer
00000060 - 00000064	Keyboard Controller
00000070 - 00000073	System CMOS/Real Time Clock
000000F0 - 000000FF	Math Co-processor
000001F0 - 000001F7	Primary IDE
00000274 - 00000277	ISAPNP Read Data Port
00000279, 00000A79	ISAPNP Configuration
000002F8 - 000002FF	Communications Port (COM2, If use)
00000378 - 0000037A	Parallel Port (If use)
000003B0 - 000003BF	MDA/MGA
000003C0 - 000003CF	EGA/VGA
000003D4 - 000003D9	CGA CRT register
000003F0 - 000003F7	Floppy Diskette
000003F6 - 000003F6	Primary IDE
000003F8 - 000003FF	Communications Port (COM1, If use)
00000400 - 0000041F	South Bridge SMB
000004D0 - 000004D1	IRQ Edge/Level Control Ports
00000500 - 0000053F	South Btidge GPIO
00000800 - 0000087F	ACPI
00000A00 - 00000A07	PME

00000A10 - 00000A17	Hardware Monitor
00000CF8	PCI Configuration Address
00000CFC	PCI Configuration Data

4.2 Interrupt Request Lines (IRQ)

Peripheral devices use interrupt request lines to notify CPU for the service required. The following table shows the IRQ used by the devices on board.

Level	Function
IRQ 0	System Timer
IRQ 1	Keyboard Controller
IRQ 2	VGA and Link to Secondary PIC
IRQ 3	Communications Port (COM2)
IRQ 4	Communications Port (COM1)
IRQ 5	PCI Device
IRQ 6	Standard Floppy Disk Controller
IRQ 7	Parallel Port
IRQ 8	System CMOS/real time clock
IRQ 9	Microsoft ACPI-Compliant System
IRQ 10	PCI Device
IRQ 11	PCI Device
IRQ 12	PS/2 Compatible Mouse
IRQ 13	FPU Exception
IRQ 14	IDE Controller
IRQ 15	PCI Device

4.3 BIOS memory mapping

Address	Device Description
00000h - 9FFFFh	DOS Kernel Area
A0000h, BFFFFh	EGA and VGA Video Buffer (128KB)
C00000h - CFFFFh	EGA/VGA ROM
D0000h - DFFFFh	Adaptor ROM
E00000h - FFFFFh	System BIOS

Any advice or comments about our products and service, or anything we can help you with please don't hesitate to contact us. We will do our best to support your products, projects and business.



Address: Global American, Inc.
17 Hampshire Drive
Hudson, NH 03051

Telephone: Toll Free (U.S. Only) 800-833-8999
(603)886-3900

FAX: (603)886-4545

Website: <http://www.globalamericaninc.com>
Support: Technical Support at Global American

