



integration with integrity

User's Manual

Single Board Computer 3307820

Version 1.0, September 2007

---

---

## **Copyrights**

This manual is copyrighted and all rights are reserved. It does not allow any non authorization in copied, photocopied, translated or reproduced to any electronic or machine readable form in whole or in part without prior written consent from the manufacturer.

In general, the manufacturer will not be liable for any direct, indirect, special, incidental or consequential damages arising from the use of inability to use the product or documentation, even if advised of the possibility of such damages. The manufacturer keeps the rights in the subject to change the contents of this manual without prior notices in order to improve the function design, performance, quality and reliability. The author assumes no responsibility for any errors or omissions, which may appear in this manual, nor does it make a commitment to update the information contained herein.

## **Trademarks**

Intel is a registered trademark of Intel Corporation.

Award is a registered trademark of Award Software, Inc.

All other trademarks, products and or product's name mentioned herein are mentioned for identification purposes only, and may be trademarks and/or registered trademarks of their respective companies or owners.

---

**Hardware:**

3307820 mini-board x 1

**Cable Kit:**

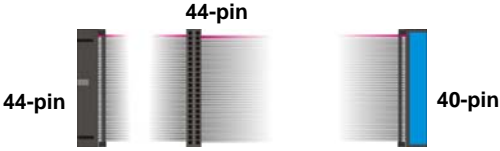

ATA33 IDE Cable x1



DC Power Cable x 1



SATA Power Cable x 1



SATA Cable x 1

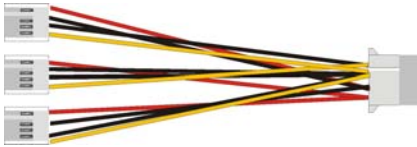

1 to 3 power output cable



PS/2 keyboard & mouse cable x 1

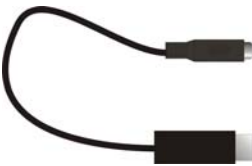

Composite Cable x 1

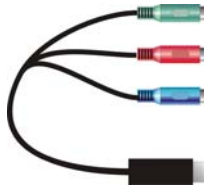

YPbPr Cable x 1



Audio Port Cable x 1



CPU Cooler x 1

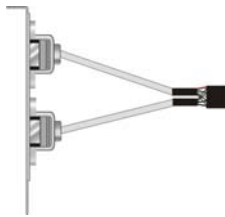

USB Cable x 1



COM Port Cable x 1

## Printed Matters:

Driver CD x 1 (including User's Manual)

## Index

<b>Chapter 1 &lt;Introduction&gt;</b> .....	<b>7</b>
1.1 <Product Overview> .....	7
1.2 <Product Specification> .....	8
1.3 <Mechanical Drawing>.....	10
1.4 <Block Diagram> .....	12
<b>Chapter 2 &lt;Hardware Setup&gt;</b> .....	<b>14</b>
2.1 <Connector Location>.....	14
2.2 <Jumper Location & Reference> .....	15
2.3 <Connector Reference>.....	16
2.3.1 <Internal Connectors> .....	16
2.3.2 <External Connectors> .....	17
2.4 <CPU and Memory Setup> .....	18
2.4.1 <CPU Setup>.....	18
2.5 <CMOS Setup> .....	19
2.6 <Enhanced IDE Interface> .....	20
2.7 <Serial ATA Interface> .....	21
2.8 <Ethernet Interface>.....	22
2.9 <Onboard Display Interface> .....	23
2.10.1 <Analog Display> .....	23
2.10.2 <Digital Display>.....	24
2.10.3 <HDTV Interface> .....	28
2.11 <Integrated Audio Interface> .....	29
2.12 <GPIO Interface> .....	31
2.13 <Power Supply> .....	32
2.13.1 <Power Input>.....	32
2.13.2 <Power Output>.....	33
2.14 <Switch and Indicator> .....	34
<b>Chapter 3 &lt;System Setup&gt;</b> .....	<b>35</b>
3.1 <Audio Configuration>.....	35

4. Select the sound mode to meet your speaker system..... 35

3.2 <Video Memory Setup> ..... 36

3.3 <Display Properties Setting>..... 38

**Appendix A <I/O Port Pin Assignment> ..... 42**

A.1 <IDE Port>..... 42

A.2 <Serial ATA Port> ..... 43

A.3 <IrDA Port> ..... 43

A.4 <Serial Port 1>..... 44

A.5 <VGA Port>..... 44

A.6 <LAN Port> ..... 45

A.7 < USB Interface > ..... 45

**Appendix C <System Resources> ..... 47**

**Appendix D <Programming GPIO's> ..... 51**

**Appendix E <Programming Watchdog Timer >..... 52**

**Appendix F <How to setting COM2 & IrDA> ..... 53**

**Contact Information ..... 54**

## Chapter 1 <Introduction>

### 1.1 <Product Overview>

**3307820** is the new generation of the 3.5 inch miniboard, with supporting Intel Core 2 Duo **socket-P** processors for 533/800MHz front side bus, Intel GME965 and ICH8M chipset, integrated GMA X3100 graphics, DDR2 memory, REALTEK High Definition Audio, Serial ATA and one Intel Gigabit LAN.

#### Intel Merom dual core Processor

The board supports Intel Core 2 Duo **socket-P** processors with 533/800MHz front side bus, 4MB L2 cache, to provide more powerful performance than before.

#### New features for Intel GME965 chipset

The board integrates Intel GME965 and ICH8M chipset, to provide new generation of the mobile solution, supports Intel GMA X3100 graphics, DDR2 533/667Mhz memory, built-in high speed mass storage interface of serial ATA, High Definition Audio .

#### All in One multimedia solution

Based on Intel GME965 and ICH8M chipset, the board provides high performance onboard graphics,18/24-bit Single/dual channel LVDS interface, HDTV and High Definition Audio, to meet the very requirement of the multimedia application.

#### Flexible Extension Interface

The board provides Compact Flash Type II slot, one mini-PCI slot.

## 1.2 <Product Specification>

### General Specification

Form Factor	3.5 inch miniboard
CPU	Support Intel Core 2 Duo Mobile Processor Package type: <b>Micro-FCPGA478 (Socket-P)</b> Front side bus: 533/800 MHz
Memory	One DDRII 533/667MHz DIMM up to 2GB with single channel Interleaved mode
Chipset	Intel GME965 & ICH8M (82801HBM)
Real Time Clock	Chipset integrated RTC with onboard lithium battery
Watchdog Timer	Generates a system reset with internal timer for 1min/s ~ 255min/s
Power Management	ACPI 1.0 compliant, supports power saving mode
PCI Enhanced IDE	One 44-pin UltraATA33 IDE interface supports up to 2 ATAPI devices
Serial ATA Interface	1 x serial ATAII interface with 300MB/s transfer rate
VGA Interface	Intel integrated extreme GMA X3100 (Graphic Media Accelerator) Technology
Video Memory	Up to 384MB shared with system memory
LVDS interface	Onboard 24-bit dual channel LVDS connector with +3.3V/+5V/+12V Supply
DVI Interface	Onboard Chronitel CH7307C DVI transmitter Support rear HDMI Connect for DVI Interface
Audio Interface	Intel integrated ICH8M with Realtek ALC888 HD Audio
LAN Interface	One Intel 82573L Gigabit LAN
Solid State Disk	IDE supports 44-pin DiskOnModule One Compact Flash Type II
GPIO interface	Onboard programmable 8-bit Digital I/O interface
Extended Interface	One Mini PCI socket to support Mini PCI Type IIIA
Internal I/O Port	2x COM, 1x GPIO port, 4 x USB ports, 1x IrDA, 1x IDE, 1XLVDS, 1x LCD inverter connector, 1x PS/2 Keyboard/Mouse Port 1x Front panel Audio connector and 1 x CDIN connector
External I/O Port	1 x LAN port, 1 x VGA port, 1x HDTV ,1 x HDMI connect 2 x USB2.0 ports, 1 x Audio Output, 1 x SPDIF connector
Power Requirement	12V DC Input
Dimension	146mm x 101mm
Temperature	Operating within 0~60 centigrade Storage within -20~85 centigrade

### Ordering Code

3307820	Support Intel Core2 Dual Mobile processor with onboard VGA, DVI, LVDS, Audio, SATA, Giga LAN, USB2.0, CF, GPIO, Mini PCI , SPDIF
---------	--

---

For further product information please visit our website at <http://www.globalamericaninc.com>.

## 1.3 &lt;Mechanical Drawing&gt;

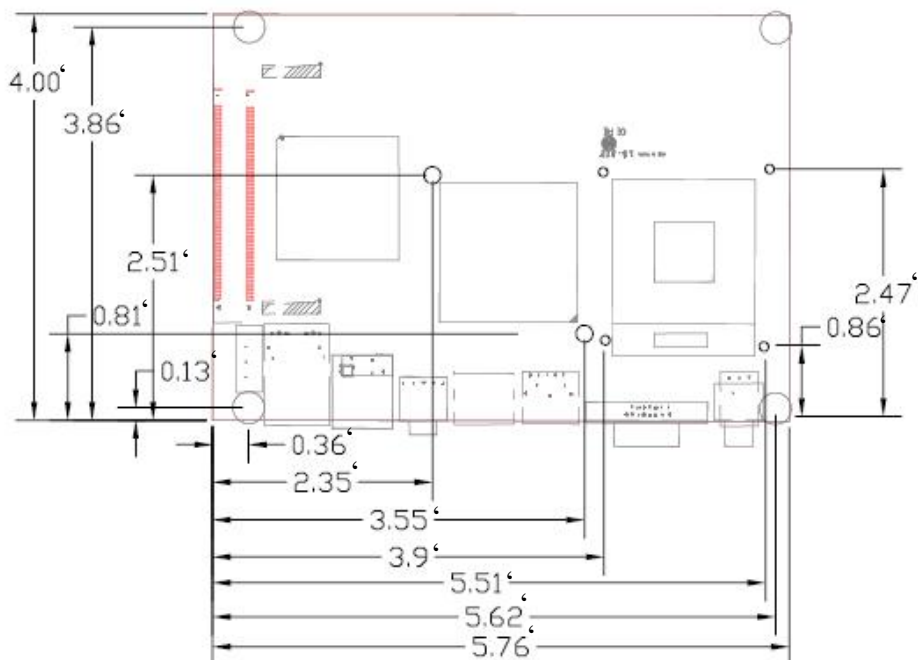

### 1.31 < IO Mechanical Drawing >

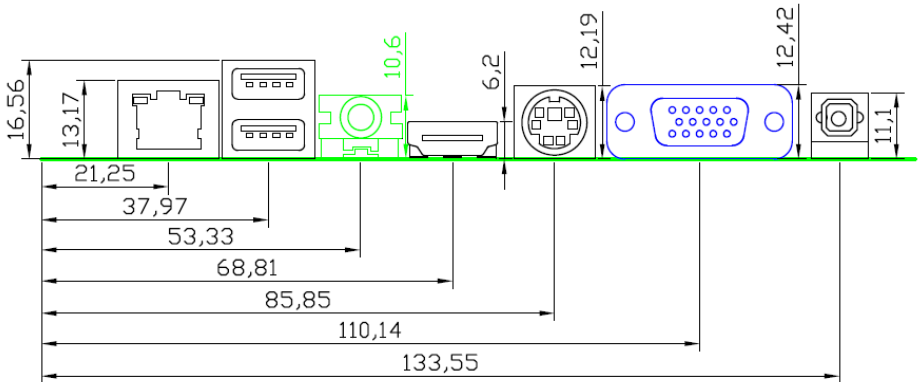

### 1.4 <Block Diagram>

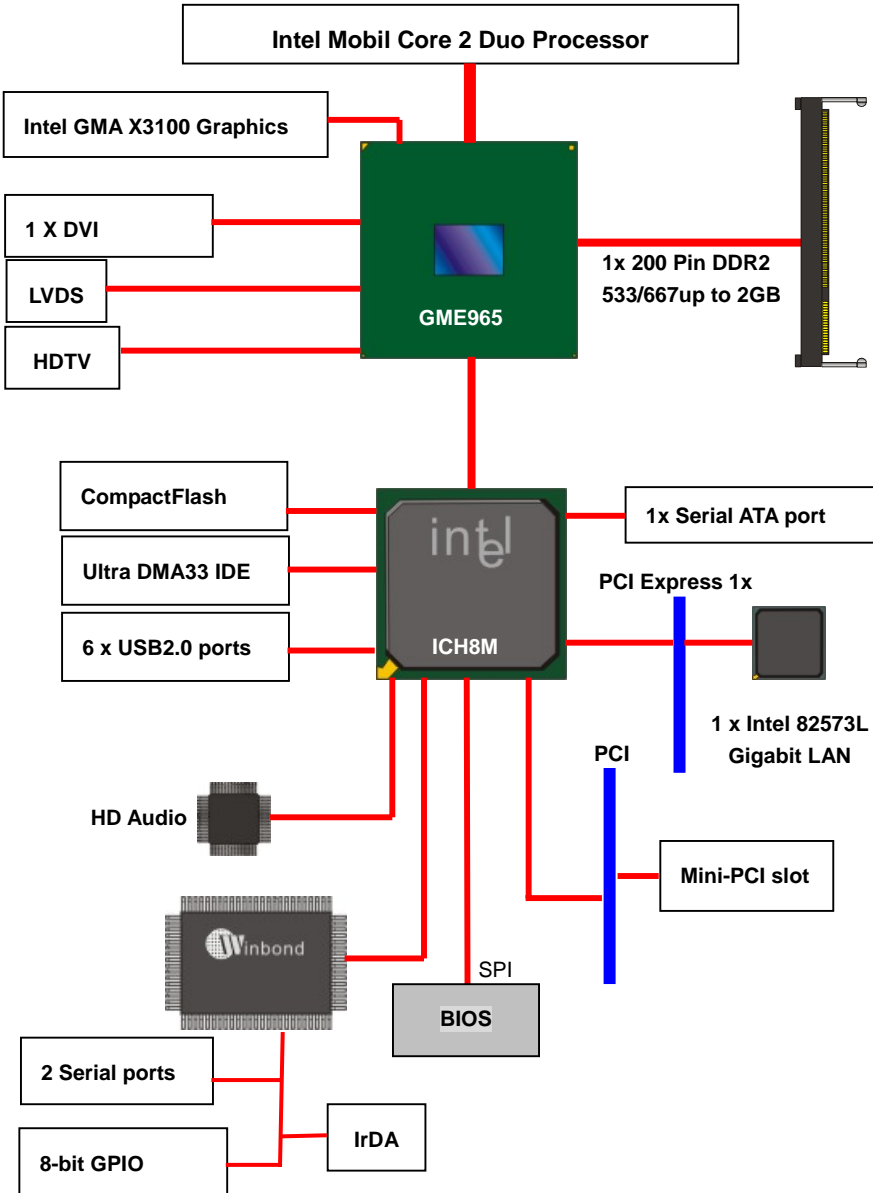

(This page is left for blank)

## Chapter 2 <Hardware Setup>

### 2.1 <Connector Location>

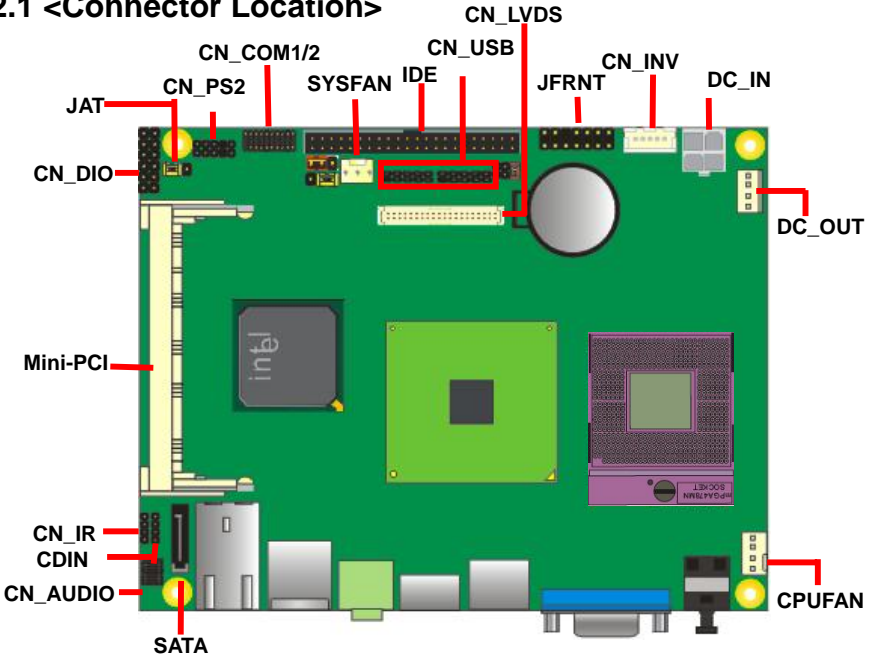

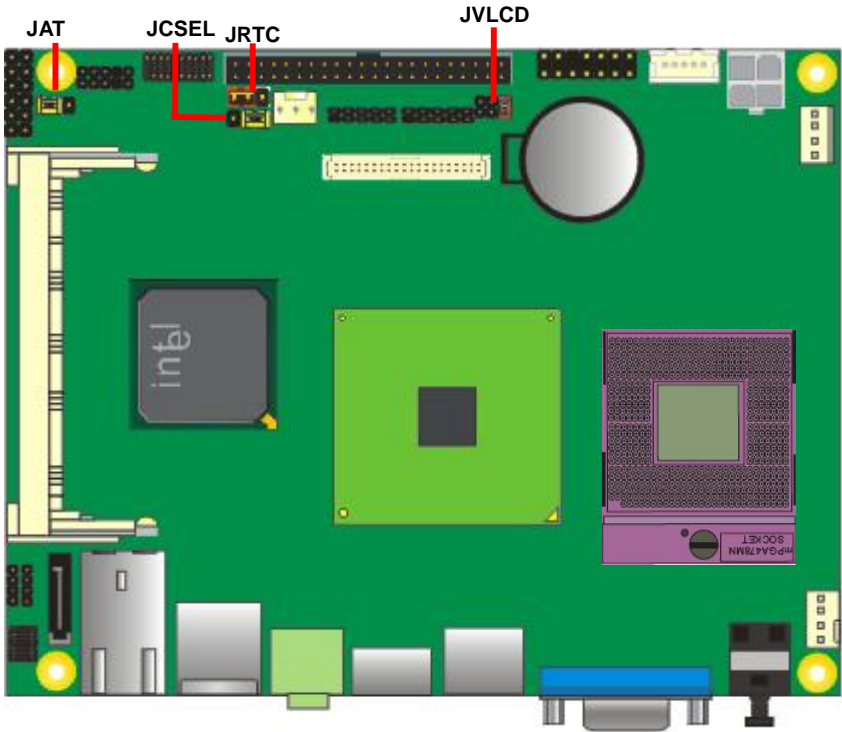

## 2.2 <Jumper Location & Reference>

Jumper	Function
JAT	Power mode select
JRTC	CMOS Operating/Clear Setting
JCSEL	IR with COM2 mode selection
JVLCD	LCD Panel Voltage Setting



Jumper: **JAT**

Type: onboard 3-pin header

Power Mode	JAT
AT Mode	 3 1
ATX Mode	 3 1
<b>Default setting: ATX Mode</b>	
	 3 1

## 2.3 <Connector Reference>

### 2.3.1 <Internal Connectors>

Connector	Function	Remark
CPU	Socket478 for <b>socket-P</b> CPU	
SO-DIMM 1	One 200 -pin DDR2 SO-DIMM slot	
IDE	44-pin IDE connector	
S_ATA1	7-pin Serial ATA connector	
DC_IN	DC <b>12V</b> input connector	
DC_OUT	4-pin power output connector	
CN_AUDIO	5 x 2-pin audio connector	
CDIN	4-pin CD-ROM audio input connector	
CN_DIO	6 x 2-pin digital I/O connector	
CN_USB	Two 5 x 2-pin USB connector	
CPUFAN	4-pin CPU cooler fan connector	
SYSFAN	3-pin system cooler fan connector	
CN_LVDS	20 x 2-pin LVDS connector	
CN_INV	5-pin LCD inverter connector	
CN_IR	5-pin IrDA connector	
JFRNT	14-pin front panel switch/indicator connector	
Min-PCI	1 x Mini-PCI socket Type IIIA	
CF	Compact Flash Type II socket	
COM1/2	Serial port connector	
JAT	Power mode select	
CN_PS2	Keyboard and mouse connector	

### 2.3.2 <External Connectors>

Connector	Function	Remark
USB	One USB connector	
CRT	DB15 analog VGA connector	
RJ45	One RJ45 LAN connector	
HDMI	HDMI Connect for DVI Interface	
HDTV	Mini Din 7-pin HDTV out	
AUDIO	Audio connector	
SPDIF	SPDIF digital audio output connector	

## 2.4 <CPU and Memory Setup>

### 2.4.1 <CPU Setup>

The board comes with the socket478 for Intel Core 2 Duo **socket-P** processor only it supports new generation of Intel Core 2 Duo **socket-P** processor with 533/800MHz of front side bus and 4MB L2 cache. Please follow the instruction to install the CPU properly.

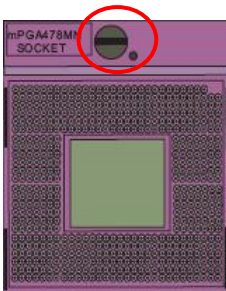

1. Use the flat-type screw drive to unlock the CPU socket

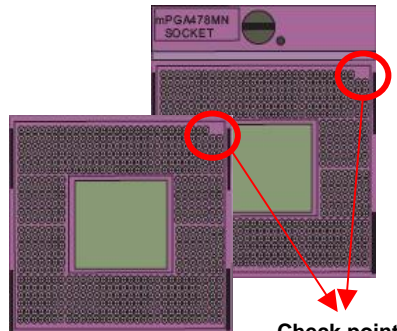
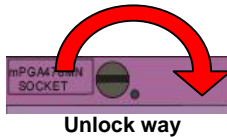

2. Follow the pin direction to install the processor on the socket

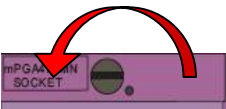

3. Lock the socket

4. Socket P has 478 pins, but is not pin-compatible with Socket M CPU.

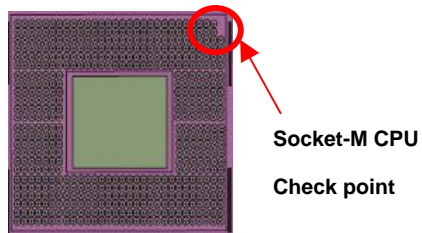

## 2.5 <CMOS Setup>

The board's data of CMOS can be setting in BIOS. If the board refuses to boot due to inappropriate CMOS settings, here is how to proceed to clear (reset) the CMOS to its default values.

### Jumper: JRTC

Type: Onboard 3-pin jumper

JRTC	Mode
1-2	Clear CMOS
2-3	Normal Operation

Default setting: 2-3

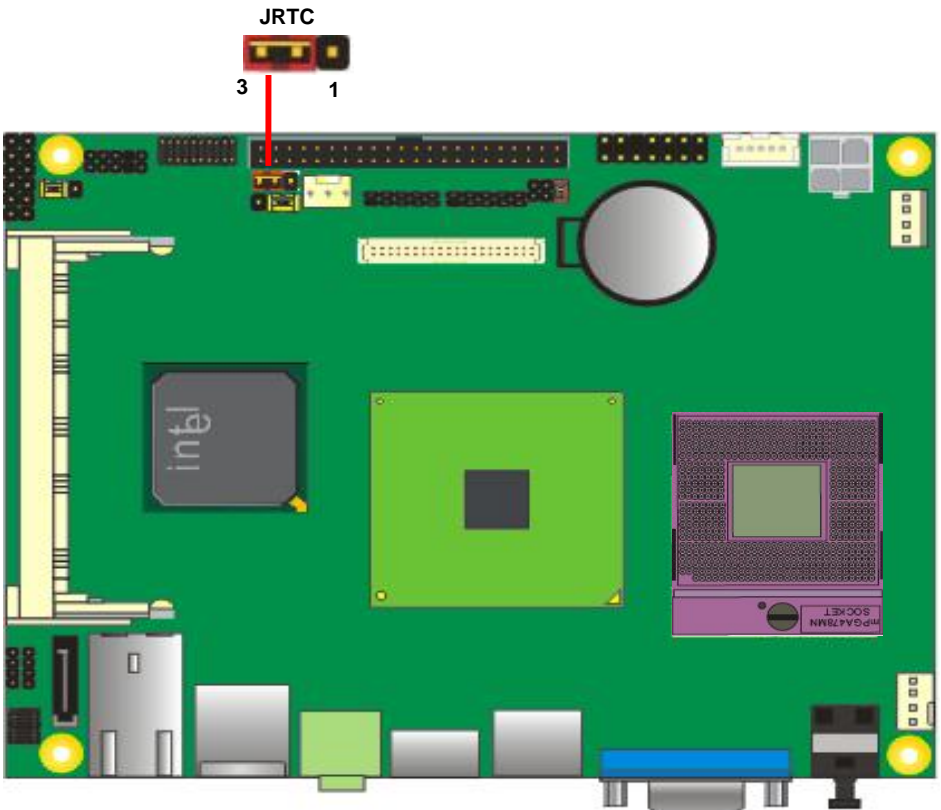

## 2.6 <Enhanced IDE Interface>

The board has one UltraDMA33 IDE interface to support up to 2 ATAPI devices, or one ATAPI device and Compact Flash Type II socket on the solder side,

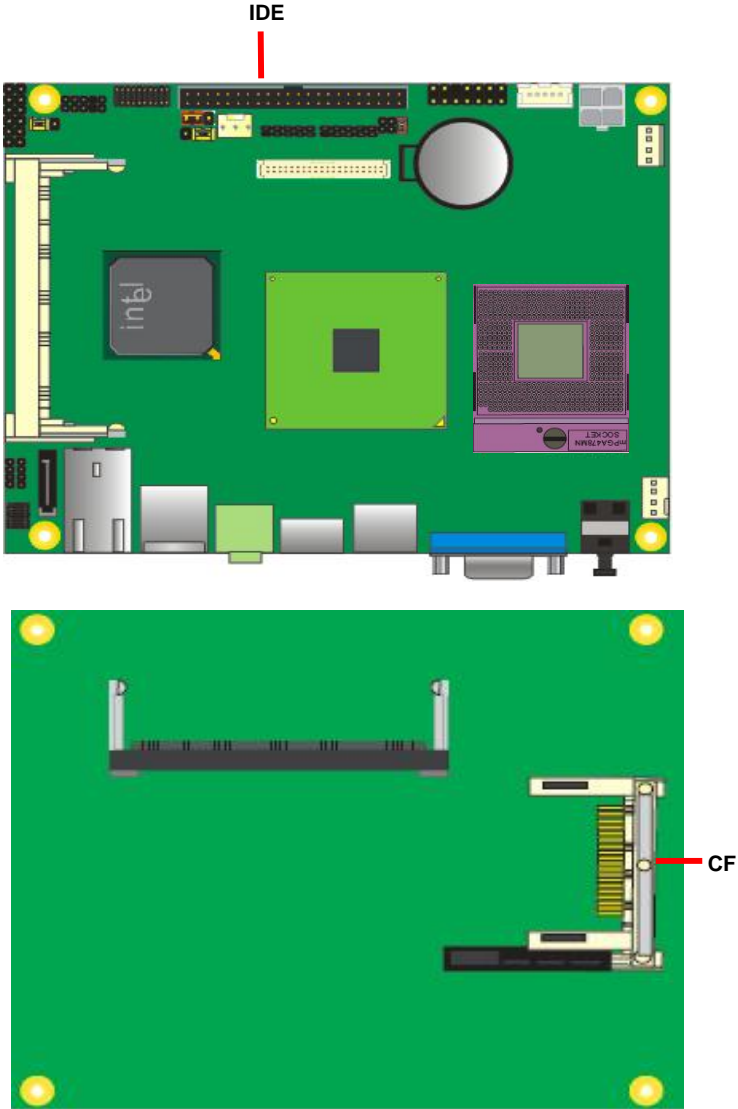

## 2.7 <Serial ATA Interface>

Based on Intel ICH8M, the board provides one Serial ATAII interfaces with up to 300MB/s of transfer rate.

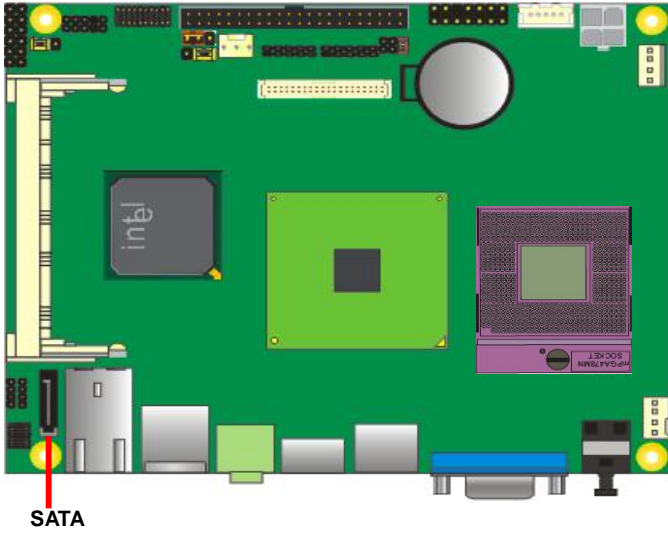

## 2.8 <Ethernet Interface>

The board integrates with one Intel PCI Express Gigabit Ethernet controllers, as the PCI Express 1x can speed up to 250MB/s of transfer rate instead of late PCI bus with 133MB/s of transfer rate. The Intel Gigabit Ethernet supports triple speed of 10/100/1000Base-T, with IEEE802.3 compliance and Wake-On-LAN supported.



## 2.9 <Onboard Display Interface>

Based on Intel GME965 chipset with built-in GMA (Graphic Media Accelerator) X3100 graphics, the board provides one DB15 connector on rear external I/O port, and one 40-pin LVDS interface with 5-pin LCD backlight inverter connector. The board provides dual display function with clone mode and extended desktop mode for CRT, LCD, TV-out and DVI.

### 2.10.1 <Analog Display>

Please connect your CRT or LCD monitor with DB15 male connector to the onboard DB15 female connector on rear I/O port.



## 2.10.2 <Digital Display>

The board provides one 40-pin LVDS connector for 18/24-bit single/dual channel panels, supports up to 1600 x 1200 (UXGA) resolution, with one LCD backlight inverter connector and one jumper for panel voltage setting.

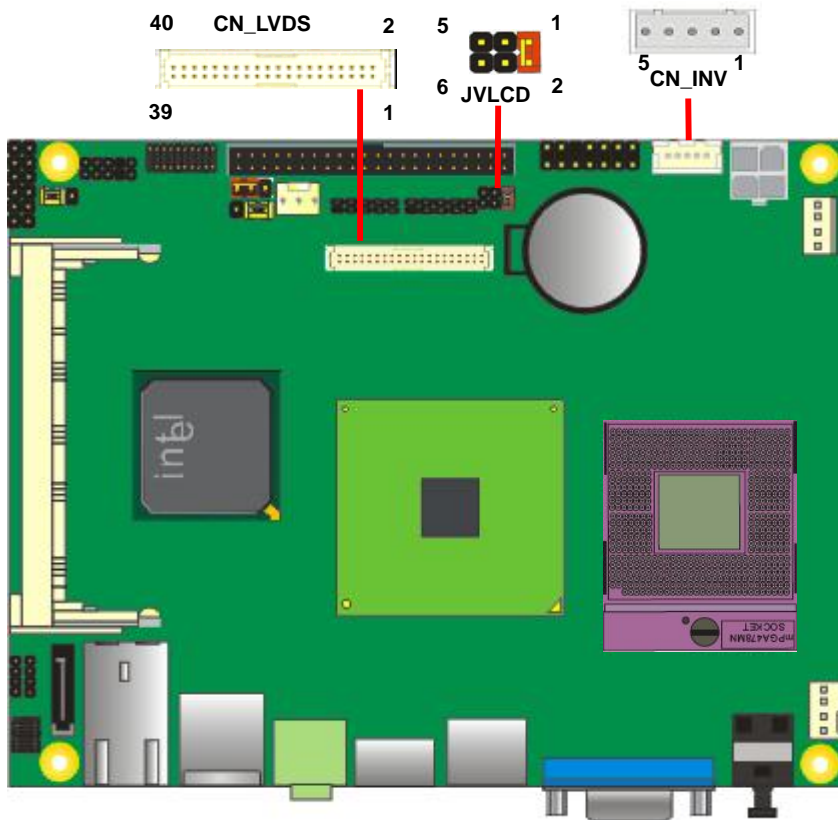

**Attention: Don't short JVLCD odd to odd pin. It could be cause serious damage.**

Connector: **CN\_INV**

Type: 5-pin LVDS Power Header

Pin	Description
1	+12V
2	CTLBKL
3	N/C
4	GND
5	ENABKL

Connector: **JVLCD**

Type: 6-pin Power select Header

Pin	Description
1-2	LCDVCC ( <b>3.3V</b> )
3-4	LCDVCC ( <b>5V</b> )
5-6	LCDVCC ( <b>12V</b> )

Connector: **CN\_LVDS**

Type: onboard 40-pin connector for LVDS connector

Connector model: **HIROSE DF13-40DP-1.25V**

Pin	Signal	Pin	Signal
2	LCDVCC	1	LCDVCC
4	GND	3	GND
6	ATX0-	5	BTX0-
8	ATX0+	7	BTX0+
10	GND	9	GND
12	ATX1-	11	BTX1-
14	ATX1+	13	BTX1+
16	GND	15	GND
18	ATX2-	17	BTX2-
20	ATX2+	19	BTX2+
22	GND	21	GND
24	ACLK-	23	BTX3-
26	ACLK+	25	BTX3+
28	GND	27	GND
30	ATX3-	29	BCLK-
32	ATX3+	31	BCLK+
34	GND	33	GND
36	DDCPCLK	35	N/C
38	DDCPDATA	37	N/C
40	N/C	39	N/C

To setup the LCD, you need the component below:

1. A panel with LVDS interfaces.
2. An inverter for panel's backlight power.
3. A LCD cable and an inverter cable.

For the cables, please follow the pin assignment of the connector to make a cable, because every panel has its own pin assignment, so we do not provide a standard cable; please find a local cable manufacture to make cables.

### LCD Installation Guide:

1. Preparing the 3307820, LCD panel and the backlight inverter.

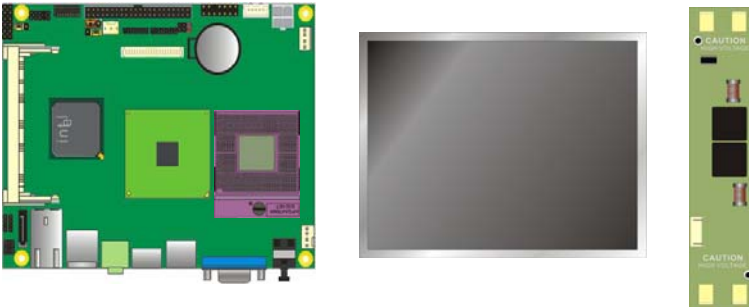

2. Please check the datasheet of the panel to see the voltage of the panel, and set the jumper **JVLCD** to +12V or +5V or +3.3V.
3. You would need a LVDS type cable.

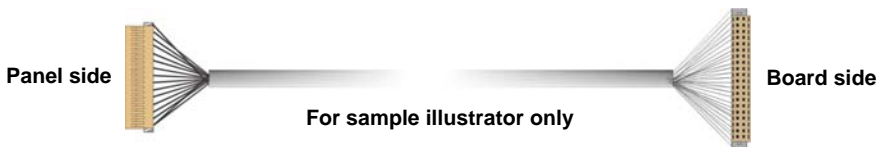

4. To connect all of the devices well.

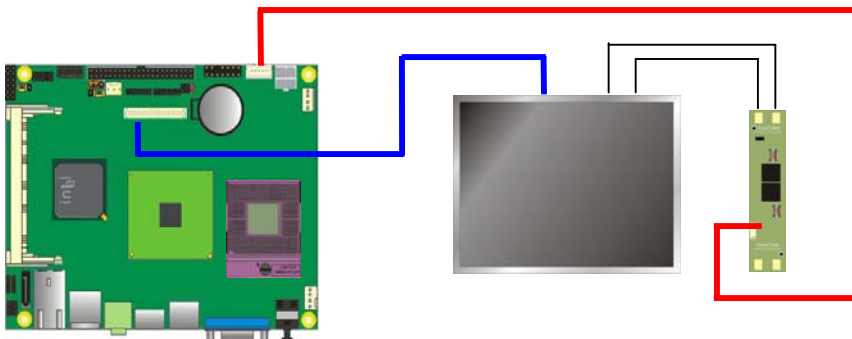

After setup the devices well, you need to select the LCD panel type in the BIOS.



BIOS panel type selection form (BIOS Version:1.3)			
18-bit Single channel		24-bit Dual channel	
NO.	Output format	NO.	Output format
1	800 x 480	10	1024 x 768
2	800 x 600	11	1280 x 768
3	1024 x 768	12	1280 x 1024
<b>24-bit Single channel</b>		13	1366 x 768
4	1024 x 768	14	1400 x 1050 @ 108Mhz
5	1280 x 768	15	1600 x 1200
6	1280 x 800		
7	1280 x 1024		
8	1366 x 768		
9	1600 x 1200		

The panel type mapping is list below:

### 2.10.3 <HDTV Interface>

The board provides an HDTV interface with Intel GME 965, supports Composite, S-Video and Component with PAL and NTSC of TV system, and display (clone or extended desktop) function with CRT,LVDS,DVI.

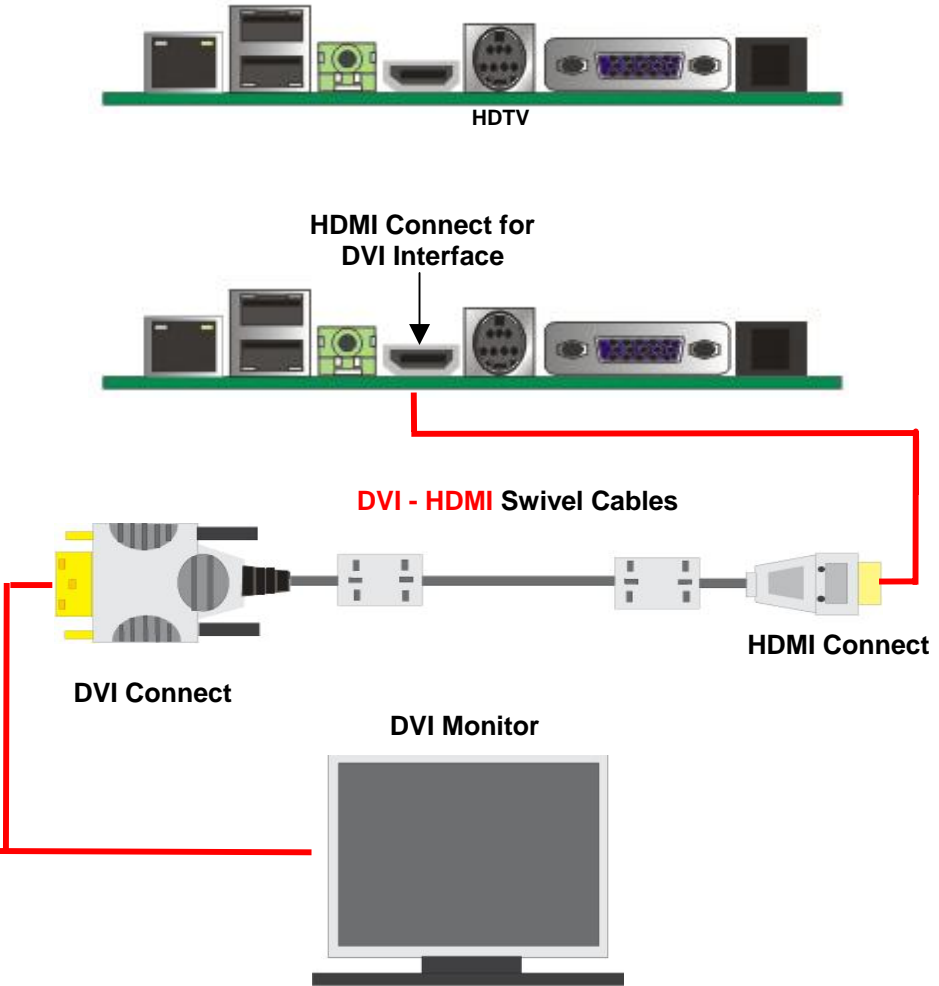

## 2.11 <Integrated Audio Interface>

The board integrates onboard audio interface with REALTEK ALC888 codec, with Intel next generation of audio standard as High Definition Audio.

The main specifications of ALC888 are:

- **High-performance DAC with 100dB S/N ratio**
- **3 DAC channels support 16/20/24-bit PCM format for 2 audio solution**
- **16/20/24-bit S/PDIF-OUT supports 44.1K/48K/96kHz sample rate**
- **Meets Microsoft WHQL/WLP 2.0 audio requirements**

The board provides 2 channels audio phone jacks on rear I/O port, and amplified speaker out and Line-out/MIC-in ports for front I/O panel through optional cable.

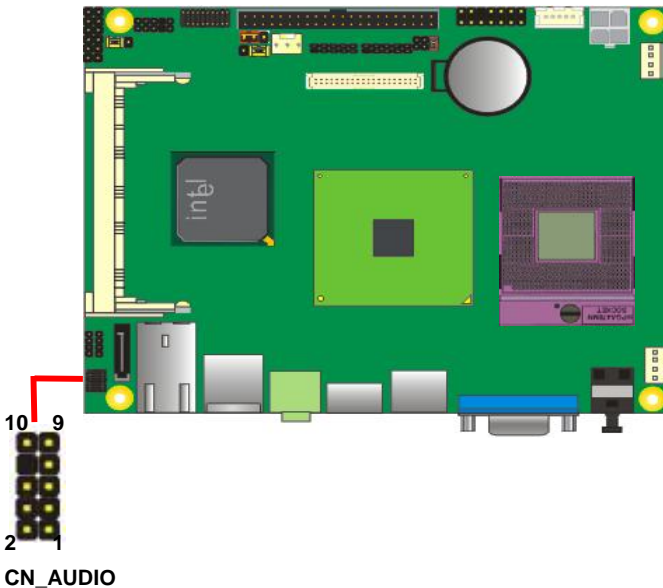

**Connector: CN\_AUDIO**

Type: 10-pin (2 x 5) 1.27mm x 2.54mm-pitch header

Pin	Description	Pin	Description
1	MIC_L	2	Ground
3	MIC_R	4	Reserve
5	Speaker_R	6	MIC Detect
7	SENSE	8	N/C
9	Speaker_L	10	Speaker Detect

**Connector: CDIN**

Type: 4-pin header (pitch = 2.54mm)

Pin	Description
1	CD – Left
2	Ground
3	Ground
4	CD – Right

## 2.12 <GPIO Interface>

The board provides a programmable 8-bit digital I/O interface; you can use this general purpose I/O port for system control like POS or KIOSK.

Connector: **CN\_DIO**

Type: 12-pin (6 x 2) 2.0mm x 2.54mm-pitch header

Pin	Description	Pin	Description
1	Ground	2	Ground
3	GP10	4	GP14
5	GP11	6	GP15
7	GP12	8	GP16
9	GP13	10	GP17
11	VCC	12	+12V

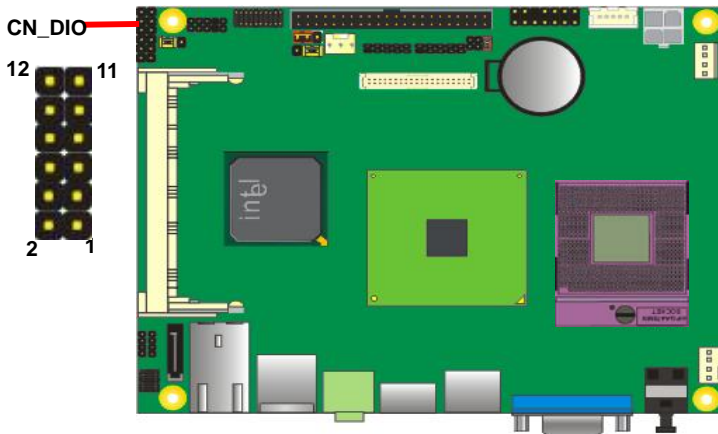

## 2.13 <Power Supply>

### 2.13.1 <Power Input>

The board requires DC 12V input with onboard 4-pin DC-input connector

the input voltage is 12V, for the input current, please take a reference of the power consumption report on appendix.

Connector: **DC\_IN**

Type: 4-pin DC power connector

Pin	Description	Pin	Description
1	Ground	4	+12V
2	Ground	3	+12V

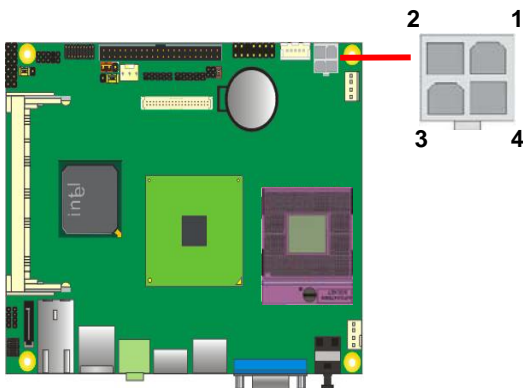

### 2.13.2 <Power Output>

The board provides one 4-pin connector for +5V/+12V output for powering your HDD, CDROM or other devices.

Connector: CN-Output

Type: 4-pin connector for +5V/+12V **Output**

Pin	Description	Pin	Description
1	+12V	2	Ground
3	Ground	4	5V

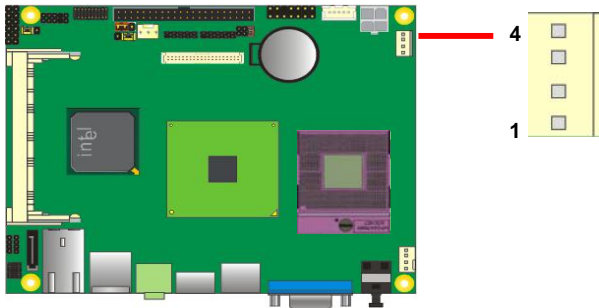

## 2.14 <Switch and Indicator>

The **JFRNT** provides front control panel of the board, such as power button, reset and beeper, etc. Please check well before you connecting the cables on the chassis.

Connector: **JFRNT**

Type: onboard 14-pin (2 x 7) 2.54-pitch header

Function	Signal	PIN		Signal	Function
IDE LED	HDLED+	1	2	PWRLED+	Power LED
	HDLED-	3	4	N/C	
Reset	Reset+	5	6	PWRLED-	Speaker
	Reset-	7	8	SPK+	
N/C		9	10	N/C	
Power Button	PWRBT+	11	12	N/C	
	PWRBT-	13	14	SPK-	

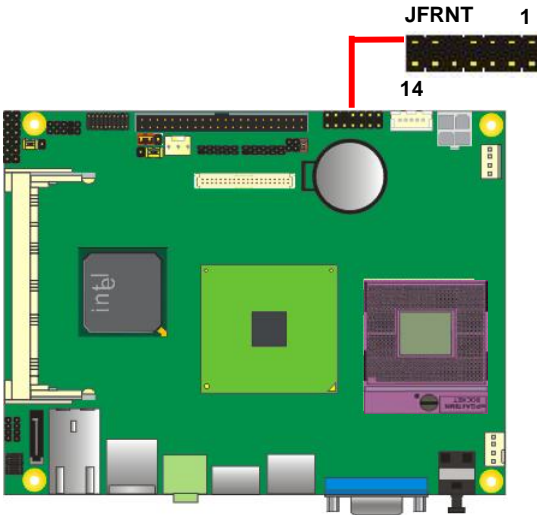

## Chapter 3 <System Setup>

### 3.1 <Audio Configuration>

The board integrates Intel® ICH8DO with REALTEK® ALC888 codec. It can support 2-channel sound under system configuration. Please follow the steps below to setup your sound system.

1. Install REALTEK HD Audio driver.
2. Launch the control panel and Sound Effect Manager.

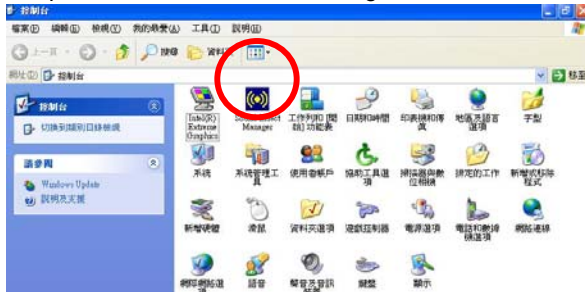

3. Select Speaker Configuration



4. Select the sound mode to meet your speaker system.

## 3.2 <Video Memory Setup>

Based on Intel® GME965 chipset with GMA (Graphic Media Accelerator) X3100, the board supports Intel® DVMT (Dynamic Video Memory Technology) 4.0, which would allow the video memory to be allocated up to 384MB.

To support DVMT, you need to install the Intel GMA X3100 Driver with supported OS.

### BIOS Setup:

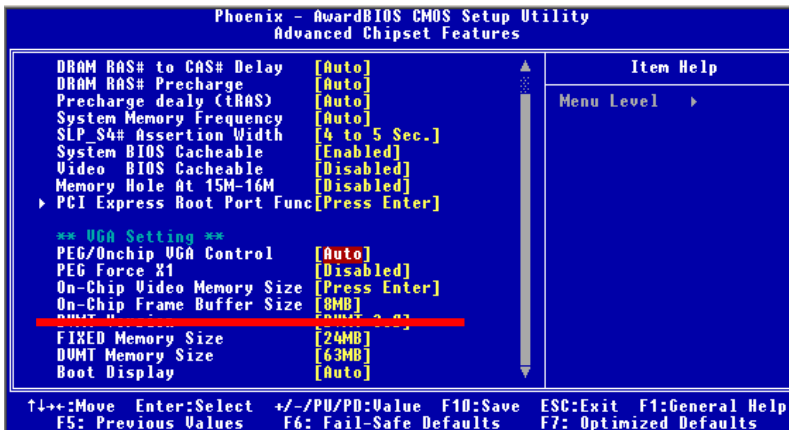

**On-Chip Video Memory Size:** This option combines three items below for setup.

#### On-Chip Frame Buffer Size:

This item can let you select video memory which been allocated for legacy VGA and SVGA graphics support and compatibility. The available option is **1MB** and **8MB**.

#### Fixed Memory Size:

This item can let you select a static amount of page-locked graphics memory which will be allocated during driver initialization. Once you select the memory amount, it will be no longer available for system memory.

#### DVMT Memory Size:

This item can let you select a maximum size of dynamic amount usage of video memory, the system would configure the video memory depends on your application, this item is strongly recommend to be selected as **MAX DVMT**.

**Fixed + DVMT Memory Size:**

You can select the fixed amount and the DVMT amount at the same time for a guaranteed video memory and additional dynamic video memory, please check the table below for available setting.

System Memory	On-Chip Frame Buffer Size	Fixed Memory Size	DVMT Memory Size	Total Graphic Memory
256MB ~ 511MB	1MB	128MB	0MB	128MB
	1MB	0MB	128MB	128MB
	8MB	128MB	0MB	128MB
	8MB	0	128MB	128MB
512MB~1023MB	1MB	128MB	0	128MB
	1MB	256MB	0	256MB
	1MB	0	128MB	128MB
	1MB	0	256MB	256MB
	8MB	128MB	0	128MB
	8MB	256MB	0	256MB
	8MB	0	128MB	128MB
	8MB	0	256MB	256MB
1024MB upper	1MB	128MB	0	128MB
	1MB	256MB	0	256MB
	1MB	0	128MB	128MB
	1MB	0	256MB	256MB
	1MB	0	MAX	384MB
	8MB	128MB	0	128MB
	8MB	256MB	0	256MB
	8MB	0	128MB	128MB
	8MB	0	256MB	256MB
	8MB	0	MAX	384MB

Notice:

1. The On-Chip Frame Buffer Size would be included in the Fixed Memory.

Please select the memory size according to this table.

### 3.3 <Display Properties Setting>

Based on Intel GME965 GMCH with GMA X3100 (Graphic Media Accelerator), the board supports two DACs for display device as different resolution and color bit.

Please install the Intel Graphic Driver before you starting setup display devices.

1. Click right button on the desktop to lunch **display properties**

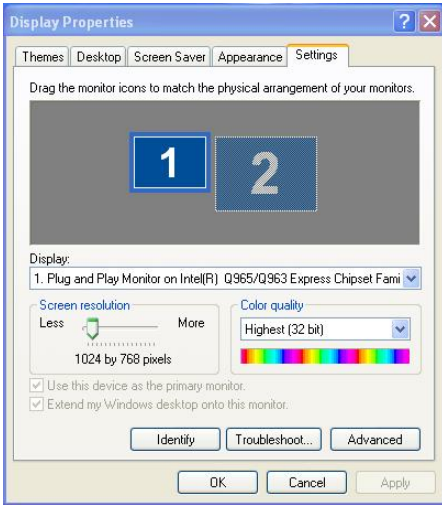

2. Click **Advanced** button for more specificity setup.

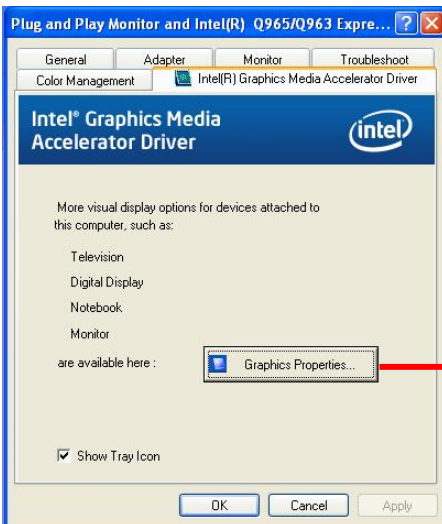

Click **Graphics Properties...** for advanced setup

3. This setup options can let you define each device settings.

Click **Monitor** to setup the CRT monitor for Colors, Resolution and Refresh Rate

Click **Intel® Dual Display Clone** to setup the dual display mode as same screen

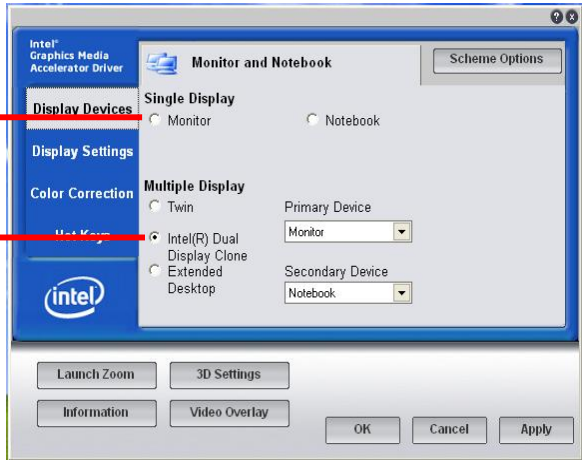

## Appendix A <I/O Port Pin Assignment>

### A.1 <IDE Port>

Connector: IDE1

Type: 44-pin (22 x 2) box header

Pin	Description	Pin	Description
1	Reset	2	Ground
3	D7	4	D8
5	D6	6	D9
7	D5	8	D10
9	D4	10	D11
11	D3	12	D12
13	D2	14	D13
15	D1	16	D14
17	D0	18	D15
19	Ground	20	N/C
21	REQ	22	Ground
23	-IOW	24	Ground
25	-IOR	26	Ground
27	IORDY	28	Ground
29	DACK	30	Ground
31	IDEIRQ	32	N/C
33	A1	34	66DET
35	A0	36	A2
37	-CS1	38	-CS3
39	-HD LED1	40	Ground
41	Vcc	42	Vcc
43	Ground	44	Ground

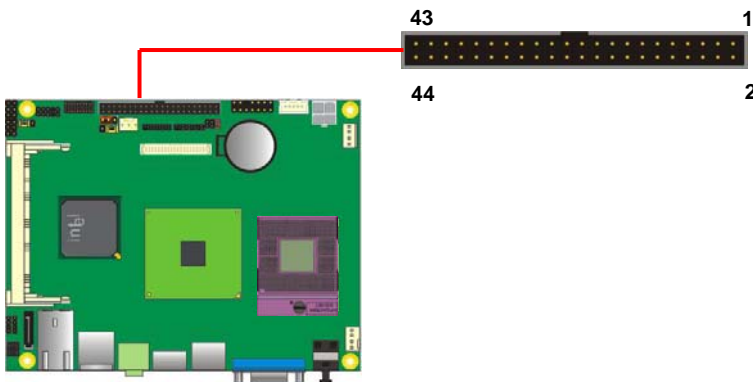

## A.2 <Serial ATA Port>

Connector: **SATA**

Type: 7-pin wafer connector

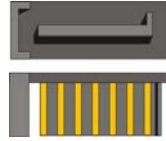

1	2	3	4	5	6	7	8	9
GND	RSATA_TXP1	RSATA_TXN1	GND	RSATA_RXN1	RSATA_RXP1	GND	GND	GND

## A.3 <IrDA Port>

Connector: **CN\_IR**

Type: 5-pin header for SIR Ports

***JCSEL must jump to "IrDA"***

Pin	Description
1	VCC
2	IRTX
3	IRRX
4	Ground



## A.4 <Serial Port >

Connector: **CN\_COM1/2**

Type: 20-pin (10 x 2) 1.27mm x 2.54mm-pitch header

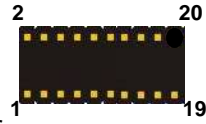

Pin	Description	Pin	Description
1	DCD	2	RXD
3	TXD	4	DTR
5	GND	6	DSR
7	RTS	8	CTS
9	RI	10	N/C
11	DCD	12	RXD
13	TXD	14	DTR
15	GND	16	DSR
17	RTS	18	CTS
19	RI	20	N/C

## A.5 <VGA Port>

Connector: **CRT**

Type: 15-pin D-sub female connector on bracket

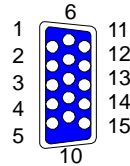

Pin	Description	Pin	Description	Pin	Description
1	RED	6	Ground	11	N/C
2	GREEN	7	Ground	12	DDCDA
3	BLUE	8	Ground	13	HSYNC
4	N/C	9	N/C	14	VSYNC
5	Ground	10	Ground	15	DDCCLK

## A.6 <LAN Port>

Connector: **RJ45**

Type: RJ45 connector with LED on bracket

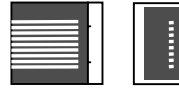

Pin	1	2	3	4	5	6	7	8
Description	MIO+	MIO-	MI1+	MI2+	MI2-	MI1-	MI3+	MI3-

## A.7 < USB Interface >

Connector: **CN\_USB**

Type: 10-pin (5 x 2) header for dual USB Ports































Pin	Description	Pin	Description
1	VCC	2	VCC
3	Data0-	4	Data1-
5	Data0+	6	Data1+
7	Ground	8	Ground
9	Ground	10	N/C

## Appendix C <System Resources>

### C1. <I/O Port Address Map>

[00000000 - 0000000F]	Direct memory access controller
[00000000 - 00000CF7]	PCI bus
[00000010 - 0000001F]	Motherboard resources
[00000020 - 00000021]	Programmable interrupt controller
[00000022 - 0000003F]	Motherboard resources
[00000040 - 00000043]	System timer
[00000044 - 0000005F]	Motherboard resources
[00000060 - 00000060]	Standard 101/102-Key or Microsoft Natural PS/2 Keyboard
[00000061 - 00000061]	System speaker
[00000062 - 00000063]	Motherboard resources
[00000064 - 00000064]	Standard 101/102-Key or Microsoft Natural PS/2 Keyboard
[00000065 - 0000006F]	Motherboard resources
[00000070 - 00000073]	System CMOS/real time clock
[00000074 - 0000007F]	Motherboard resources
[00000080 - 00000090]	Direct memory access controller
[00000091 - 00000093]	Motherboard resources
[00000094 - 0000009F]	Direct memory access controller
[000000A0 - 000000A1]	Programmable interrupt controller
[000000A2 - 000000BF]	Motherboard resources
[000000C0 - 000000DF]	Direct memory access controller
[000000E0 - 000000EF]	Motherboard resources
[000000F0 - 000000FF]	Numeric data processor
[00000170 - 00000177]	Secondary IDE Channel
[000001F0 - 000001F7]	Primary IDE Channel
[00000274 - 00000277]	ISAPNP Read Data Port
[00000279 - 00000279]	ISAPNP Read Data Port
[000002F8 - 000002FF]	Communications Port (COM2)
[00000376 - 00000376]	Secondary IDE Channel
[00000380 - 0000038B]	Mobile Intel(R) 965 Express Chipset Family
[000003C0 - 000003DF]	Mobile Intel(R) 965 Express Chipset Family
[000003F6 - 000003F6]	Primary IDE Channel
[000003F8 - 000003FF]	Communications Port (COM1)
[00000400 - 000004BF]	Motherboard resources
[000004D0 - 000004D1]	Motherboard resources
[00000500 - 0000051F]	Intel(R) ICH8 Family SMBus Controller - 283E

	[00000680 - 000006FF] Motherboard resources
	[00000880 - 000008FF] Motherboard resources
	[00000A79 - 00000A79] ISAPNP Read Data Port
	[00000D00 - 0000FFFF] PCI bus
	[0000C000 - 0000CFFF] Intel(R) ICH8 Family PCI Express Root Port 1 - 283F
	[0000CF00 - 0000CF1F] Intel(R) PRO/1000 PL Network Connection
	[0000D000 - 0000DFFF] Intel(R) ICH8 Family PCI Express Root Port 2 - 2841
	[0000F300 - 0000F30F] Intel(R) ICH8M 3 port Serial ATA Storage Controller - 2828
	[0000F400 - 0000F40F] Intel(R) ICH8M 3 port Serial ATA Storage Controller - 2828
	[0000F500 - 0000F503] Intel(R) ICH8M 3 port Serial ATA Storage Controller - 2828
	[0000F600 - 0000F607] Intel(R) ICH8M 3 port Serial ATA Storage Controller - 2828
	[0000F700 - 0000F703] Intel(R) ICH8M 3 port Serial ATA Storage Controller - 2828
	[0000F800 - 0000F807] Intel(R) ICH8M 3 port Serial ATA Storage Controller - 2828
	[0000F900 - 0000F90F] Intel(R) ICH8M Ultra ATA Storage Controllers - 2850
	[0000FA00 - 0000FA1F] Intel(R) ICH8 Family USB Universal Host Controller - 2832
	[0000FB00 - 0000FB1F] Intel(R) ICH8 Family USB Universal Host Controller - 2831
	[0000FC00 - 0000FC1F] Intel(R) ICH8 Family USB Universal Host Controller - 2830
	[0000FD00 - 0000FD1F] Intel(R) ICH8 Family USB Universal Host Controller - 2835
	[0000FE00 - 0000FE1F] Intel(R) ICH8 Family USB Universal Host Controller - 2834
	[0000FF00 - 0000FF07] Mobile Intel(R) 965 Express Chipset Family
	(PCI) 18 Intel(R) ICH8 Family USB Universal Host Controller - 2832
	(PCI) 18 Intel(R) ICH8 Family USB2 Enhanced Host Controller - 283A
	(PCI) 19 Intel(R) ICH8 Family USB Universal Host Controller - 2831
	(PCI) 19 Intel(R) ICH8M 3 port Serial ATA Storage Controller - 2828
	(PCI) 21 Intel(R) ICH8 Family USB Universal Host Controller - 2835
	(PCI) 22 Microsoft UAA Bus Driver for High Definition Audio
	(PCI) 23 Intel(R) ICH8 Family USB Universal Host Controller - 2830
	(PCI) 23 Intel(R) ICH8 Family USB2 Enhanced Host Controller - 2836

## C2. <Memory Address Map>

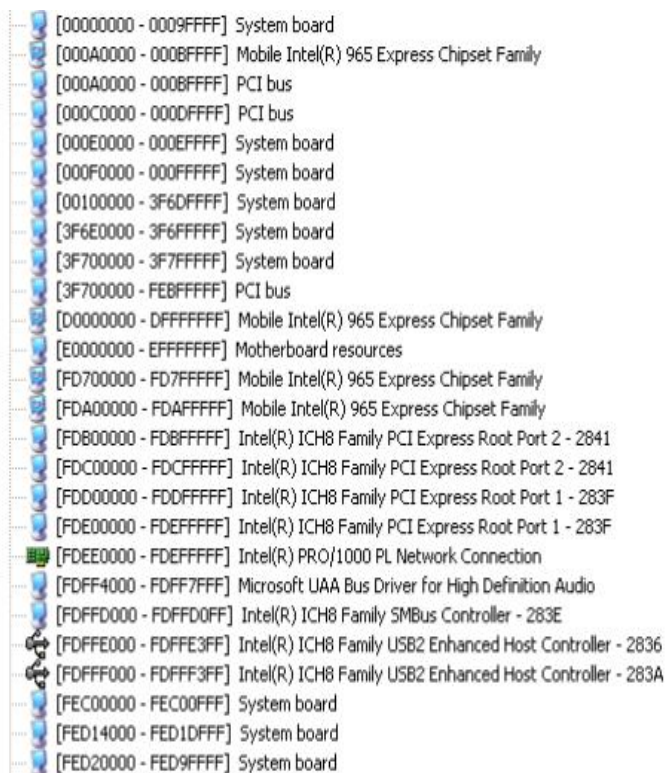







[00000000 - 0009FFFF]	System board
[000A0000 - 000BFFFF]	Mobile Intel(R) 965 Express Chipset Family
[000A0000 - 000BFFFF]	PCI bus
[000C0000 - 000DFFFF]	PCI bus
[000E0000 - 000EFFFF]	System board
[000F0000 - 000FFFFF]	System board
[00100000 - 3F6DFFFF]	System board
[3F6E0000 - 3F6FFFFF]	System board
[3F700000 - 3F7FFFFF]	System board
[3F700000 - FEBFFFFF]	PCI bus
[D0000000 - DFFFFFFF]	Mobile Intel(R) 965 Express Chipset Family
[E0000000 - EFFFFFFF]	Motherboard resources
[FD700000 - FD7FFFFF]	Mobile Intel(R) 965 Express Chipset Family
[FDA00000 - FDAFFFFF]	Mobile Intel(R) 965 Express Chipset Family
[FD800000 - FDBFFFFF]	Intel(R) ICH8 Family PCI Express Root Port 2 - 2841
[FDC00000 - FDCFFFFF]	Intel(R) ICH8 Family PCI Express Root Port 2 - 2841
[FDD00000 - FDDFFFFF]	Intel(R) ICH8 Family PCI Express Root Port 1 - 283F
[FDE00000 - FDEFFFFF]	Intel(R) ICH8 Family PCI Express Root Port 1 - 283F
[FDEE0000 - FDEFFFFF]	Intel(R) PRO/1000 PL Network Connection
[FDFF4000 - FDFF7FFF]	Microsoft UAA Bus Driver for High Definition Audio
[FDFFD000 - FDFFD0FF]	Intel(R) ICH8 Family SMBus Controller - 283E
[FDFFE000 - FDFFE3FF]	Intel(R) ICH8 Family USB2 Enhanced Host Controller - 2836
[FDFFF000 - FDFFF3FF]	Intel(R) ICH8 Family USB2 Enhanced Host Controller - 283A
[FEC00000 - FEC00FFF]	System board
[FED14000 - FED1DFFF]	System board
[FED20000 - FED9FFFF]	System board

### C3. <System IRQ & DMA Resources>

#### DMA:

-  2 Standard floppy disk controller
-  4 Direct memory access controller

#### IRQ:

-  (ISA) 0 System timer
-  (ISA) 1 Standard 101/102-Key or Microsoft Natural PS/2 Keyboard
-  (ISA) 3 Communications Port (COM2)
-  (ISA) 4 Communications Port (COM1)
-  (ISA) 6 Standard floppy disk controller
-  (ISA) 8 System CMOS/real time clock
-  (ISA) 9 Microsoft ACPI-Compliant System
-  (ISA) 13 Numeric data processor
-  (ISA) 14 Primary IDE Channel
-  (ISA) 15 Secondary IDE Channel
-  (PCI) 11 Intel(R) ICH8 Family SMBus Controller - 283E
-  (PCI) 16 Intel(R) ICH8 Family PCI Express Root Port 1 - 283F
-  (PCI) 16 Intel(R) ICH8 Family USB Universal Host Controller - 2834
-  (PCI) 16 Intel(R) PRO/1000 PL Network Connection #2
-  (PCI) 16 Mobile Intel(R) 965 Express Chipset Family
-  (PCI) 17 Intel(R) ICH8 Family PCI Express Root Port 2 - 2841
-  (PCI) 17 Intel(R) PRO/1000 PL Network Connection
-  (PCI) 18 Intel(R) ICH8 Family USB Universal Host Controller - 2832
-  (PCI) 18 Intel(R) ICH8 Family USB2 Enhanced Host Controller - 283A
-  (PCI) 19 Intel(R) ICH8 Family USB Universal Host Controller - 2831
-  (PCI) 19 Intel(R) ICH8M 3 port Serial ATA Storage Controller - 2828
-  (PCI) 21 Intel(R) ICH8 Family USB Universal Host Controller - 2835
-  (PCI) 22 Microsoft UAA Bus Driver for High Definition Audio
-  (PCI) 23 Intel(R) ICH8 Family USB Universal Host Controller - 2830
-  (PCI) 23 Intel(R) ICH8 Family USB2 Enhanced Host Controller - 2836

## Appendix D <Programming GPIO's>

The GPIO's can be programmed with the MSDOS debug program using simple IN/OUT commands. The following lines show an example how to do this.

```
GPIO0.....GPIO7  bit0.....bit7
-o 2E 87                ;enter configuration
-o 2E 87
-o 2E 07
-o 2F 09                ;enale GPIO function
-o 2E 30
-o 2F 02                ;enable GPIO configuration
-o 2E F0
-o 2F xx                ;set GPIO as input/output; set '1' for input,'0' for
output
-o 2E F1
-o 2F xx                ;if set GPIO's as output,in this register its value
                        can be set
```

Optional :

```
-o 2E F2
-o 2F xx                ; Data inversion register ; '1' inverts the current
                        valus of the bits , '0' leaves them as they are
-o 2E 30
-o 2F 01                ; active GPIO's
```

For further information ,please refer to Winbond W83627DHG datasheet.

## Appendix E <Programming Watchdog Timer >

The watchdog timer makes the system auto-reset while it stops to work for a period. The integrated watchdog timer can be setup as system reset mode by program.

### Timeout Value Range

- 1 to 255
- Second or Minute

### Program Sample

Watchdog timer setup as system reset with 5 second of timeout

---

```

2E, 87
2E, 87
2E, 07
2F, 08      Logical Device 8
2E, 30      Activate
2F, 01
2E, F5      Set as Second*
2F, 00
2E, F6      Set as 5
2F, 05

```

---

\* Minute: bit 3 = 0; Second: bit 3 = 1

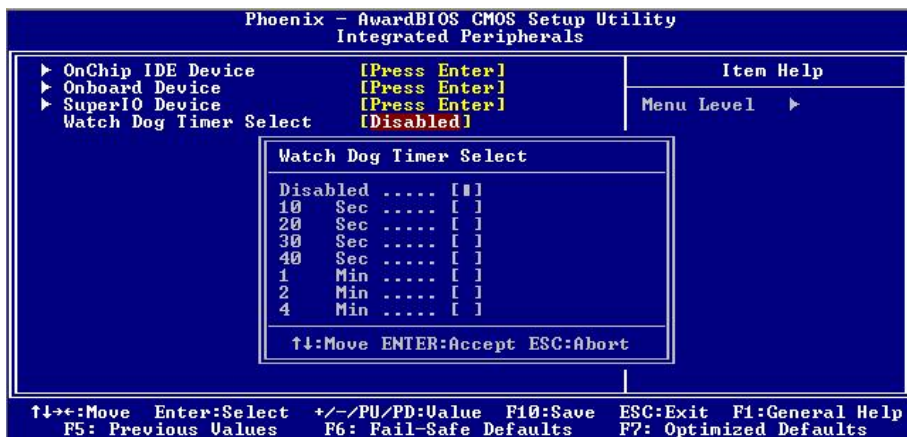

You can select Timer setting in the BIOS, after setting the time options, the system will reset according to the period of your selection.



## Appendix F <How to setting COM2 & IrDA>

Jumper: **JCSEL**

Type: onboard 3-pin header

Power Mode	JAT
IR Mode	 3      1
COM2 Mode	 3      1
Default setting: COM2 Mode	
	 3      1

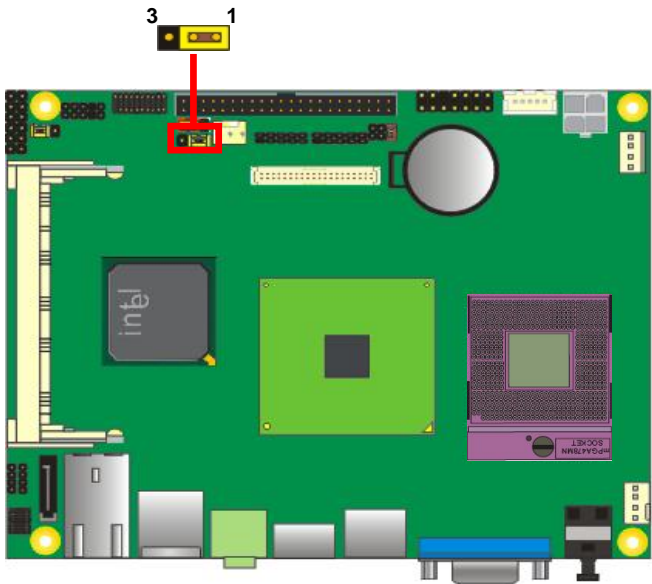

---

Any advice or comments about our products and service, or anything we can help you with please don't hesitate to contact with us. We will do our best to support your products, projects and business.



Address: Global American, Inc.  
17 Hampshire Drive  
Hudson, NH 03051

Telephone: Toll Free (U.S. Only) 800-833-8999  
(603)886-3900

FAX: (603)886-4545

Website: <http://www.globalamericaninc.com>

E-Mail: [salesinfo@globalamericaninc.com](mailto:salesinfo@globalamericaninc.com)

---