



User's Manual

3303449

Copyright© 2000,2001

All Right Reserved.

Manual Edition 1.2, March 2001

The information in this document is subject to change without prior notice in order to improve the reliability, design and function. It does not represent a commitment on the part of the manufacturer.

Under no circumstances will the manufacturer be liable for any direct, indirect, special, incidental, or consequential damages arising from the use or inability to use the product or documentation, even if advised of the possibility of such damages.

This document contains proprietary information protected by copyright. All rights are reserved. No part of this manual may be reproduced by any mechanical, electronic, or other means in any form without prior written permission of the manufacturer.

Trademarks

SIS is a trademark of Silicon Integrated System Corp.; DiskOnChip(r)2000 and TrueFFS are registered trademarks of M-Systems Inc.; IBM PC is a registered trademark of International Business Machines Corporation; Intel is a registered trademark of Intel Corporation; AMD is a registered trademark of Advanced Micro Devices, Inc.; AWARD is a registered trademark of Award Software international, Inc.. Other product names mentioned herein are used for identification purposes only and may be trademarks and/or registered trademarks of their respective companies.

Table of Contents

Introduction	1
Specifications	2
Component Locations	6
Dimensions	7
Board Layout	8
Jumper / Connector Quick Reference	9
CPU and CMOS Jumper Settings	10
CPU Clock Speed (JR0~JR2, JF0~JF2)	10
CPU Voltage (JV0~JV4)	11
CMOS Operation (JRTC)	11
Watchdog Timer	12
Mode Setting (JP4)	12
Time-out Setting (SWDT)	12
Programming Example	13
DiskOnChip® 2000 Flash Disk	14
Installation Instructions	14
Power Connectors	15
Power Connector (PWRCON1)	15
ATX Power Control (PWRCON2)	15
CPU / System Fan Connector (CPUFAN1 / SYSFAN1)	15
Ethernet 10Base-T/100-Base-TX	16
Disabling the Ethernet Controller	17
LAN Port Signals	17
LAN LED Indicator (LED)	17
Audio ESS Solo-1 ES-19385	18
Disabling the Audio Controller	19
Serial Port COM2 Mode (RS-232/485)	19
COM RS-232C/485 Selection (J2)	19
Switches and Indicators	20
Interface Connectors HDD, FDD	21
Floppy Disk Drive (Floppy)	21
EIDE Connector (Primary_IDE, Secondary_IDE)	22

Peripheral Ports	23
Parallel Port (Print)	23
USB Port (USB)	23
Onboard RS-232 Serial Port (JCOM1,2,3,4)	24
RS-485 Serial Ports (RS1)	24
IrDA (SIR)	24
16-bit General Purpose I/O (JDIO)	24
Flat Panel VGA (LCD1)	25
CRT SVGA (VGAH)	25
PS/2 Keyboard (PS2-KB)	27
PS/2 Mouse (PS2-MS)	27
Audio Interface (JAUDIO)	27
CDROM audio interface (MITSUMI)	27
System Resources	27
SIS-530 AGP for CRT	29
Memory Assignment	29
C&T 69000 Flat Panel Controller	30
Flat Panel Connector (LCD)	30
LCD Voltage Selection (JVOLT1)	30
PLANAR EL640.480-AA1	32
KYOCERA KCB104VG2BA-A01	33
SHARP LQ12S41	34
HITACHI LMG9211XUCC	35
NAN YALTBSHOT24GC	36
TORISAN MXS121022010	37
NEC NL8060AC26-04	38
AWARD BIOS Setup	40
Standard CMOS Setup	41
BIOS Features Setup	44
Chipset Features Setup	47
Power Management Setup	50
PNP/PCI Configuration	53
Hardware Monitor	55
Integrated Peripherals (3303449 version)	56
Integrated Peripherals (3303449C version)	56
POST Codes	59
Audible Error Messages	59
Visible Error Messages	59
POST Card Error Messages	61
Howto : Flash the BIOS	66
Warranty	67

Introduction

The 3303449 is a 5.25" drive size single board computer that can drive both CRT and Flat Panel Displays.

The board supports the latest high speed socket 7 CPUs. With its small form factor and high performance, the board is a cost/effective solution for demanding application such as GUI-based MMI solutions or high speed server/controller functions.

Enhanced IDE, high-speed I/O

A Built-in fast PCI IDE controller supports ATA PIO/DMA and Ultra DMA33/66with transfer rates of up to 66MB/s.

A separate data path for both IDE channels improves the overall performance under multi-tasking environments. In addition, the 3303449 has 4 RS-232 series ports with 16C550 and 16-Byte FIFO and 1 bi-directional printer port that supports SPP, ECP, and EPP modes. For enhanced data transfer, USB and IrDA ports are available.

Flat Panel / CRT SVGA

The chips C&T69000 is a highly integrated graphics/flat panel controller integrating 2MB SDRAM, graphics, flat panel, and CRT control logic on the same die. The C&T69000 delivers super 2D video performance and consumes minimal power.

DiskOnChip®2000

The SSD socket accommodates a DiskOnChip®2000, a new generation of high performance single-chip Flash Disks. This unique data storage solution offers a better, faster and more cost-effective Flash Disk for applications with limited space and modest disk capacity requirements.

Watchdog Timer

The onboard Watchdog Timer can invoke an NMI or system RESET when your application loses control over the system.

Specifications

- CPU : AMD-K6® -3 Processor with 3DNow!™ up to 550 MHz
AMD K5/K6/K6-2, Cyrix M1/M2, Intel Pentium P54C/P55C
- Chipset : SIS 530 (Host, PCI, 3D A.G.P. Video/Graphics)
- BIOS : AWARD PCI/ISA PnP system BIOS
- Green Function : power saving options supported in BIOS. DOZE / STANDBY / SUSPEND modes
- Secondary Cache : write Back Cache Mode with Direct Mapped Cache Organization, 512 KB Pipelined Burst SRAM (up 1MB - 2MB)
- DRAM Memory : up to 1024 MB of EDO or SDRAM in two 168-pin DIMM sockets
- Bus Interface : PCI and PC/104
- Data Bus : PCI - 32-bit, PC/104 - 16 bit
- Bus Speeds : PCI - 33.3 MHz, PC/104 - 8.3 MHz
- DMA Controllers : 8237 x 2 (7 channels)
- Interrupt Controllers : 8259 x 2 (15 levels)
- PCI Enhanced IDE with Ultra DMA : supports two ports and up to four ATAPI devices. Supports IDE PIO Timing Mode 0, 1, 2 ,3 and 4, Multiword DMA Mode 0, 1, 2 and Ultra DMA 33/66
- Watchdog Timer :
generates an NMI or system RESET when your application loses control over the system. The timer interval is:
1, 2, 10, 20, 110 and 220 seconds .
- Real-time Clock : included in SIS-530 with lithium battery backup for 10 years of data retention. CMOS data backup of BIOS setup and BIOS default.
- Keyboard and Mouse Connectors:
5-pin header connector for PS/2 Mouse
5-pin header connector for AT or PS/2 Keyboard

High Speed Multi I/O

- Chipset : ITE 8661F
- Serial Ports : 3 high speed RS-232C ports COM1/COM3/COM4, 1 high speed RS-232C/485 port COM2 (jumper selectable). Both with 16C550 compatible UART and 16 byte FIFO.
- Game Port : one port 16-pin header
- USB : two onboard USB ports (12 Mb/s and 1.5 Mb/s)
- SIR Interface : 5-pin IrDA TX/RX header
- Digital I/O : 16-bit GPIO, 8 independent GPI and 8 independent GPO programable by software.
- Floppy Disk Drive Interface :
up to two floppy drives, 5¼ " (360 KB or 1.2 MB) and 3½ " (720 KB, 1.44 MB or 2.88 MB). BIOS enabled/disabled
- Bi-directional Parallel Port : SPP, EPP and ECP mode.

External Expansion slots

- PC/104 : 104-pin connector for a 16-bit bus
- PCI : one standard 32-bit PCI bus expansion connector

AGP/PCI 3D graphics accelerator for CRT

- Chipset : SIS- 530 AGP, 2x AGP supports up to 133 MHz
- BIOS : combined with system BIOS
- Memory : up to 8 MB SDRAM shared with system memory
- Display Type : CRT (VGA, SVGA, XGA, SXGA)
- Connectors : 15-pin header

PCI graphics accelerator for Flat Panel

- Chipset : CHIPS C&T 69000 HiQVideo™ Accelerator with 2 MB integrated SDRAM on chip
- BIOS : combined with system BIOS
- Display Type : CRT, TFT, DSTN, SSTN, EL, Plasma Quarter VGA (VGA, SVGA, XGA)
- Connectors : 50-pin box header for Flat Panel display and 15-pin header for CRT (C&T 69000)

10BASE-T/100BASE-TX PCI Ethernet

- Chipset : Realtek RTL8139A(or compatible)
- Type : 10BASE-T / 100BASE-TX
- Connector : 10-pin box header

PCI AUDIO Interface

- Chipset : ESS Solo-1 ES-19385, 3D Sound onboard
- Connectors : 9-pin header for AUXA, AUXB, Mic/Speaker and 4-pin mini box header for CDROM audio cable

Flash Disk DiskOnChip®2000

- Package : Single Chip Flash Disk in 32-pin DIP JEDEC
- Capacity : 1-288 MByte

Environmental and Power

- Power Requirements : + 5V @ 2.8A (Intel Pentium 233 + 64MB SDRAM), ±12 V
- Connectors : 3-pin CPU fan power, 3-pin system fan power 6-pin power source block
- System Monitoring and Alarm : CPU and System temperature, system voltage and cooling fan RPM.
- Board Dimensions : 146 mm x 203 mm (5.75" x 8.0") LxW
- Board Weight : 0.28 Kg
- Operating Temperature: 0 to 55°C (32 to 131°F)

This page intentionally left blank

Warning

Single Board Computers and their components contain very delicate Integrated Circuits (IC). To protect the Single Board Computer and its components against damage from static electricity, you should always follow the following precautions when handling it :

1. Disconnect your Single Board Computer from the power source when you want to work on it
2. Always hold the board by the edges and try not to touch the IC chips, leads or circuitry
3. Use a grounded wrist strap when handling computer components.
4. Place components on a grounded antistatic pad or on the bag that came with the Single Board Computer, whenever components are separated from the board

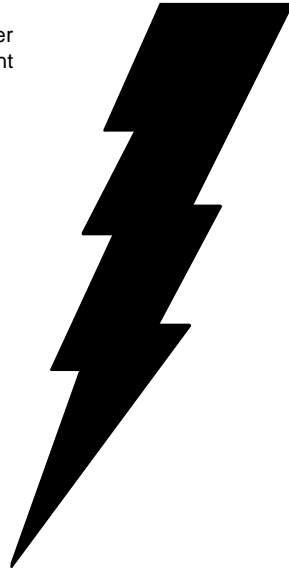

Component Locations

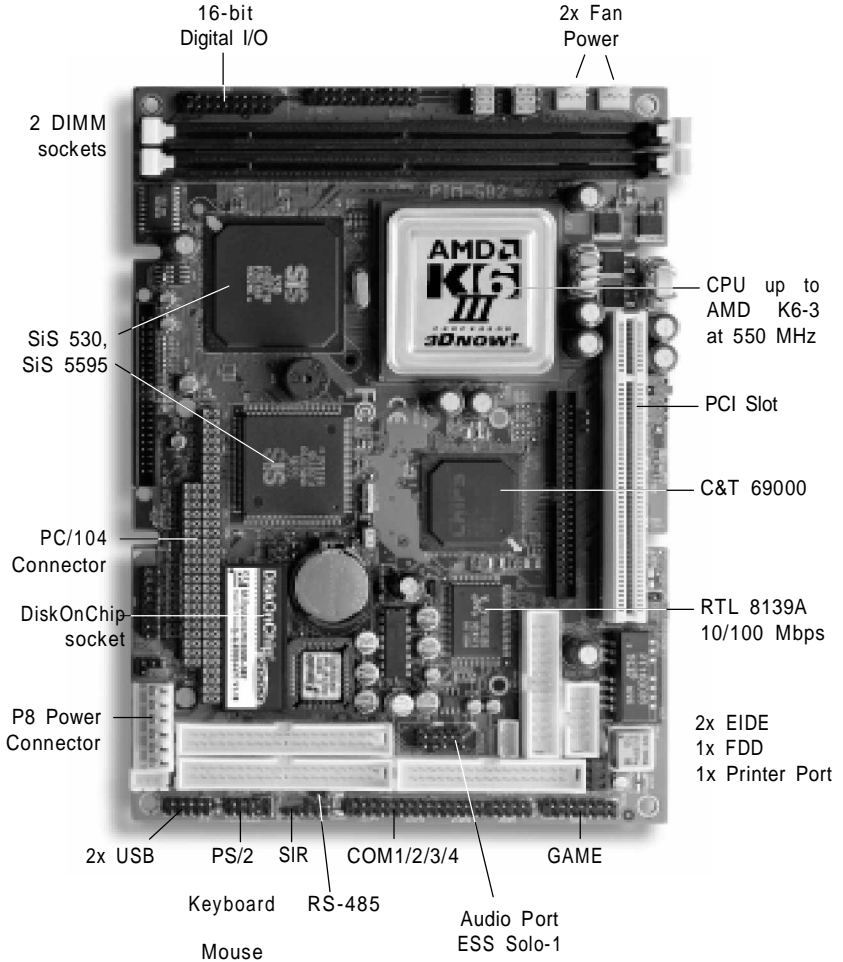

Board Layout

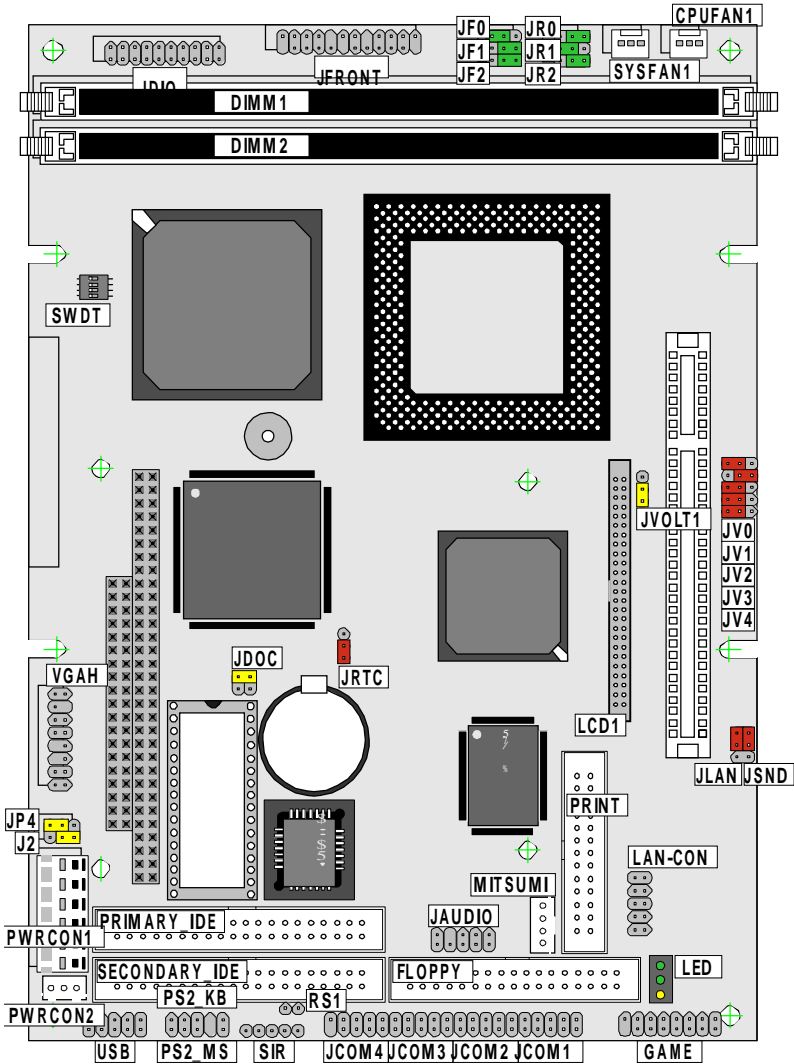

Jumper Color coding :

Red	=	Voltage Settings
Green	=	CPU Speed Ratio
Yellow	=	General configuration

Jumper / Connector Quick Reference

Jumpers

JV0~JV4 CPU Core Voltage

JV0	JV1	JV2	JV3	JV4	Volts
2-3	2-3	1-2	1-2	1-2	1.9 V
2-3	1-2	1-2	1-2	1-2	2.0 V
1-2	2-3	2-3	2-3	2-3	2.1 V
2-3	1-2	2-3	2-3	2-3	2.2 V
1-2	1-2	2-3	2-3	2-3	2.3 V
2-3	2-3	1-2	2-3	2-3	2.4 V
1-2	2-3	1-2	2-3	2-3	2.5 V
2-3	2-3	2-3	1-2	2-3	2.8 V
1-2	2-3	2-3	1-2	2-3	2.9 V
2-3	2-3	1-2	1-2	2-3	3.2 V
1-2	2-3	1-2	1-2	2-3	3.3 V
1-2	1-2	1-2	1-2	2-3	3.5 V

JF0~JF2 FSB Speed

JF0	JF1	JF2	Speed
1-2	1-2	1-2	66.8 MHz
1-2	1-2	2-3	75.0 MHz
1-2	2-3	1-2	83.3 MHz
1-2	2-3	2-3	95.0 MHz
2-3	1-2	1-2	100 MHz
2-3	1-2	2-3	112 MHz
2-3	2-3	1-2	124 MHz
2-3	2-3	2-3	133 MHz

JR0~JR2 FSB / CPU Core Ratio

JR0	JR1	JR2	ratio
2-3	2-3	2-3	x 1.5
1-2	2-3	2-3	x 2.0
1-2	1-2	2-3	x 2.5
2-3	1-2	2-3	x 3.0
2-3	2-3	2-3	x 3.5
1-2	2-3	1-2	x 4.0
1-2	1-2	1-2	x 4.5
2-3	1-2	1-2	x 5.0
2-3	2-3	1-2	x 5.5

JRTC RTC/CMOS Operation

1-2	->	Clear
2-3	->	Normal

JDOC DiskOnChip Base Address

1-2	->	D0000h
3-4	->	D8000h

JVOLT LCD voltage Selection

1-2	->	5 V
2-3	->	3.3 V

JLAN LAN Enable/Disable

1-2	->	Enable
2-3	->	Disable

JSND Audio Enable/Disable

1-2	->	Enable
2-3	->	Disable

J2 COM2 RS-232C/485 Mode

1-2	->	RS-232C
2-3	->	RS-485

JP4 Watchdog Active Mode

1-2	->	IOCHK
2-3	->	RESET
off	->	Disabled

SWDT Watchdog Timer Timeout

1	2	3	4	Timeoff
	off	on	off	1 sec
off	off	on	on	2 sec
off	on	off	off	10 sec
on	off	off	off	20 sec
on	off	off	on	110 sec
on	off	off	on	220 sec

Connectors

CPUFAN1	3-pin CPU Fan Power
SYSFAN1	3-pin system Fan Power
JFRONT	Signals, RESET
JDIO	20-pin Digital I/O header
LCD1	50-pin Flat Panel header
VGAH	16-pin VGA boxheader
PRINT	LPT1, Parallel Port
FLOPPY	34-pin FDD interface
PRI_IDE	40-pin Primary IDE
SEC_IDE	40-pin Secondary IDE
JAUDIO	9-pin audio header
MITSUMI	4-pin CDROM audio
LAN-CON	10-pin LAN header
PWRCON1	6-pin Power Connector
PS2_KB	PS/2 Keyboard
PS2_MS	PS/2 Mouse
SIR	5-pin IrDA header
COM1,2,3,4	four 9-pin COM headers
USB	10-pin USB Port
RS1	2-pin COM2 RS-485
LED	LAN traffic LED

CPU and CMOS Jumper Settings

CPU Clock Speed (JR0~JR2, JF0~JF2)

CPU type	JR0	JR1	JR2	JF0	JF1	JF2
Intel Pentium 100MHz (3.3V)	2-3	2-3	2-3	1-2	1-2	1-2
Intel Pentium 133MHz (3.3V)	1-2	2-3	2-3	1-2	1-2	1-2
Intel Pentium 166MHz (3.3V)	1-2	1-2	2-3	1-2	1-2	1-2
Intel Pentium 200MHz (3.3V)	2-3	1-2	2-3	1-2	1-2	1-2
Intel P55C 166MHz (2.8V)	1-2	1-2	2-3	1-2	1-2	1-2
Intel P55C 200MHz (2.8V)	2-3	1-2	2-3	1-2	1-2	1-2
Intel P55C 233MHz (2.8V)	2-3	2-3	2-3	1-2	1-2	1-2
Cyrix M2 PR-200 (2.9V)	1-2	1-2	2-3	1-2	1-2	1-2
Cyrix MX PR-233 (2.9V)	2-3	1-2	2-3	1-2	1-2	1-2
IDT C6-180 (3.5V)	2-3	1-2	2-3	1-2	1-2	1-2
IDT C6-200 (3.5V)	2-3	1-2	2-3	1-2	1-2	1-2
AMD K5 PR133 (2.9V)	1-2	2-3	2-3	1-2	1-2	1-2
AMD K5 PR166 (2.9V)	1-2	1-2	2-3	1-2	1-2	1-2
AMD K6 166 (2.9V)	1-2	1-2	2-3	1-2	1-2	1-2
AMD K6 200 (2.9V)	2-3	1-2	2-3	1-2	1-2	1-2
AMD K6 233 (3.2V)	2-3	2-3	2-3	1-2	1-2	1-2
AMD K6-2 266 (2.2 V)	1-2	2-3	1-2	1-2	1-2	1-2
AMD K6-2 300 (2.2 V)	2-3	1-2	2-3	2-3	1-2	1-2
AMD K6-2 350 (2.2 V)	2-3	2-3	2-3	2-3	1-2	1-2
AMD K6-3 400 (2.4 V)	1-2	2-3	1-2	2-3	1-2	1-2
AMD K6-3 450 (2.4 V)	1-2	1-2	1-2	2-3	1-2	1-2
AMD K6-3 500 (2.4 V)	2-3	1-2	1-2	2-3	1-2	1-2
default setting						

CPU Voltage (JV0~JV4)

CPU Voltage	JV0	JV1	JV2	JV3	JV4
1.9V	2-3	2-3	1-2	1-2	1-2
2.0V	2-3	1-2	1-2	1-2	1-2
2.1V	1-2	2-3	2-3	2-3	2-3
2.2V	2-3	1-2	2-3	2-3	2-3
2.3V	1-2	1-2	2-3	2-3	2-3
2.4V	2-3	2-3	1-2	2-3	2-3
2.5V	1-2	2-3	1-2	2-3	2-3
2.8V	2-3	2-3	2-3	1-2	2-3
2.9V	1-2	2-3	2-3	1-2	2-3
3.2V	2-3	2-3	1-2	1-2	2-3
3.3V	1-2	2-3	1-2	1-2	2-3
3.5V	1-2	1-2	1-2	1-2	2-3

default setting

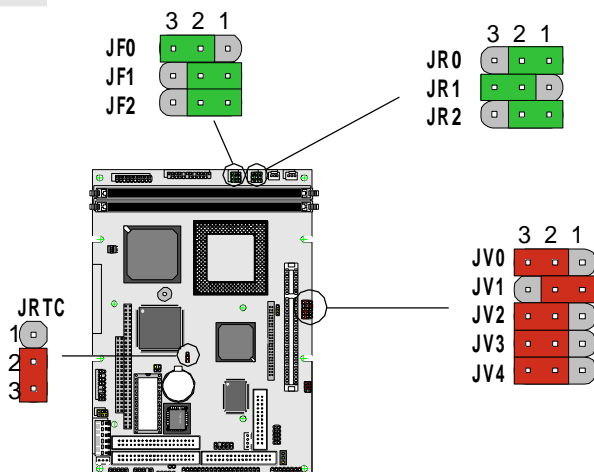

CMOS Operation (JRTC)

If the 3303449 refuses to boot due to inappropriate CMOS settings here is how to proceed to clear (reset) the CMOS to its default values

Mode	JRTC
Normal Operation	2-3
Clear CMOS	1-2

default setting

Watchdog Timer

The onboard watchdog timer can be disabled by jumper setting or enabled for either reboot by RESET or invoking an NMI.(non-maskable interrupt).

Even if enabled by jumper setting upon boot the watchdog timer is always inactive. To initialize the watchdog timer reading of port 444H is sufficient. To disable the watchdog timer read port 44H.

After the watchdog timer has been initialized by reading port 444H, it has to be strobed at preconfigured intervals to keep it from issuing a RESET or NMI. Intervals can also be selected by jumper setting. Strobing of the watchdog is done by reading port the same port that initializes the watchdog timer: port 444H. Failure to strobe before the configured period expires, indicating a program halt/abort, resulting in a RESET or NMI.

Mode Setting (JP4)

Watchdog Mode	JP4
RESET	2-3
I0CHK	1-2
Disable Watchdog timer	OFF

default setting

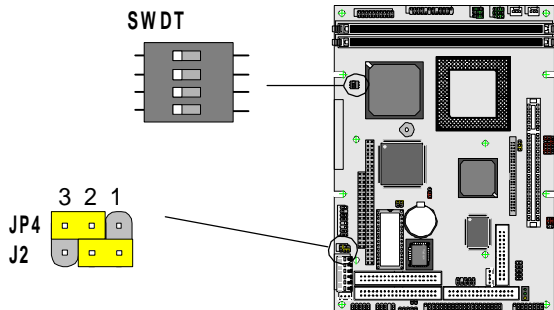

Time-out Setting (SWDT)

Watchdog Time-out Period	1	2	3	4
1 sec	OFF	OFF	ON	OFF
2 sec	OFF	OFF	ON	ON
10 sec	OFF	ON	OFF	OFF
20 sec	OFF	ON	OFF	ON
110 sec	ON	OFF	OFF	OFF
220 sec	ON	OFF	OFF	ON

default setting

Watchdog Timer Program Control

Function	Required Action
Enable/refresh the Watch -Dog	I/O Read 444H
Disable the Watch-Dog Timer.	I/O Read 044H

Programming Example

The following program is an examples of how to enable, disable and refresh the Watchdog timer:

```
WDT_EN_RF      EQU      0444H
WDT_DIS        EQU      0044H

WT_Enable      PUSH     AX                ;save AX DX
                PUSH     DX
                MOV      DX,WDT_EN_RF    ;enable the watchdog
                IN       AL,DX
                POP      DX                ;reco AX DX
                POP      AX
                RET

WT_Rresh       PUSH     AX                ;save AX DX
                PUSH     DX
                MOV      DX,WDT_ET_RF    ;refresh the watchdog
                IN       AL,DX
                POP      DX                ;reco AX, DX
                RET

WT_DISABLE     PUSH     AX
                PUSH     DX
                MOV      DX,WDT_DIS;    disable the watchdog
                IN       AL,DX
                POP      DX                ;reco AX, DX
                POP      AX
                RET
```

DiskOnChip® 2000 Flash Disk

Installation Instructions

1. Make sure the 3303449 is powered OFF.
2. Plug the DOC (DiskOnChip 2000) device into its socket. Verify the direction is correct (pin 1 of the DiskOnChip 2000 is aligned with pin 1 of the socket)

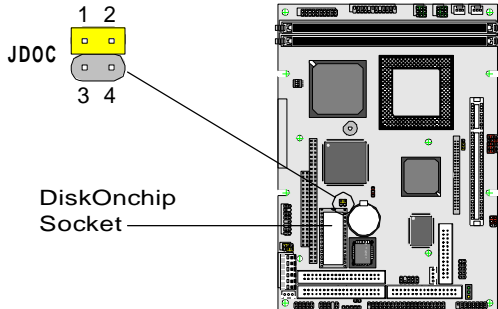

3. Set address

Base Address	JDOC
D0000h	1-2
D8000h	3-4

default setting

4. Power up the system
5. During power up you may observe a message displayed by the DOC when its drivers are automatically loaded into system's memory
6. At this stage the DOC can be accessed as any disk in the system
7. If the DOC is the only disk in the system, it will appear as the first disk (drive C: in DOS)
8. If there are more disks besides the DOC, the DOC will appear by default as the last drive, unless it was programmed as first drive. (please refer to the DOC utilities user manual)
9. If you want the DOC to be bootable:
 - a - copy the operating system files into the DOC by using the standard DOS command (for example: sys d:)
 - b - The DOC should be the only disk in the systems or should be configured as the first disk in the system (c:) using the DUPDATE utility

For more information on DiskOnChip2000, visit M-Systems Web site at

[http:// www.m-sys.com](http://www.m-sys.com)

where you can find Utilities Manual, Data Sheets and Application Notes. In addition, you can find the latest DiskOnChip 2000 S/W Utilities

Power Connectors

Power Connector (PWRCON1)

Connector : PWRCON1

Type : 6-pin P8

Pin	Description			
1	GND	4	+12V	
2	GND	5	+5V	
3	-12V	6	PG (power good)	

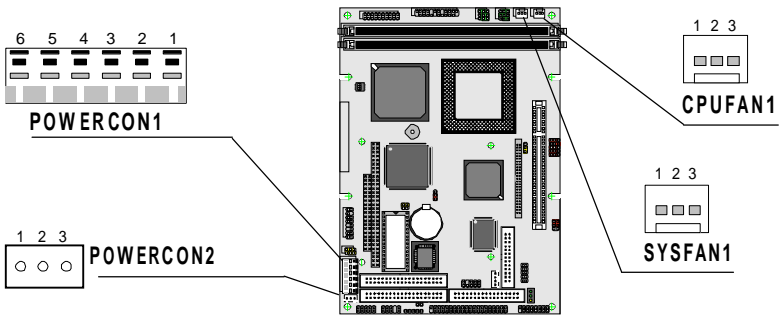

ATX Power Control (PWRCON2)

Connector : PWRCON2

Type : 3-pin onboard header

Pin	Description
1	5 V SB (standby)
2	GND
3	PS-ON

CPU / System Fan Connector (CPUFAN1 / SYSFAN1)

Connector : CPUFAN1/SYSFAN1

Type : 3-pin onboard header box

Pin	Description
1	FanTach
2	+12 V
3	GND

Ethernet 10Base-T/100-Base-TX

The Realtek RTL8139B(L) is a highly integrated and cost-effective single-chip Fast Ethernet controller that provides 32-bit performance, PCI bus master capability, and full compliance with IEEE 802.3u 100Base-T specifications and IEEE 802.3x Full Duplex Flow Control and n-way auto-negotiation.

Power Management and Wake-up

The RTL8139BL supports Advanced Configuration Power management Interface (ACPI), PCI power management for modern operating systems that is capable of Operating System Directed Power Management (OSPM) to achieve the most efficient power management.

Besides ACPI, the RTL8139B(L) also supports remote wake-up in both ACPI and APM environments. The RTL8139B(L) is capable of generating an internal reset whenever there (auxiliary) power is applied. Once auxiliary power is on whereas the main power still remains off, the RTL8139B(L) is ready and is waiting for the Magic packet or LinkChange to wake the system up.

Supported operating systems :

DOS/Windows

NDIS2 (DOS, OS/2, Lantastic, WFW3.1.....)

NDIS3, NDIS4, NDIS5 for Win95, 98, NT 3.51, 4.0, 5.0, WFW3.11

Netware 16-bit ODI driver for DOS, OS/2 and 32-bit ODI driver for Netware 3.x, 4.x, 5.0 Server

Packet driver for UNIX Client

SCO Unix driver

Linux driver

FreeBSD

UnixWare 7.0

For latest drivers go to :

<http://www.realtek.com.tw>

Disabling the Ethernet Controller

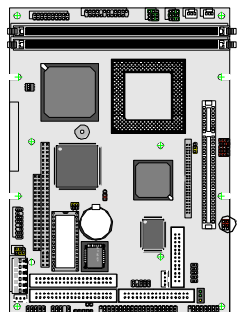

Connector : JLAN
Type : onboard 3-pin header

State	JLAN
Enabled	1-2
Disabled	2-3
default setting	

LAN Port Signals

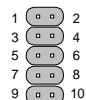

Pin	Description	Pin	Description
1	TX+	2	TX-
3	RX+	4	N/C
5	N/C	6	RX-
7	N/C	8	N/C
9	GND	10	GND

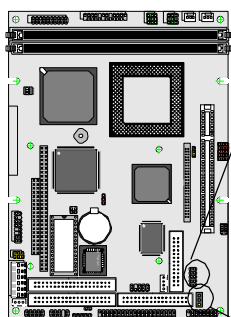

LAN LED Indicator (LED)

Connector: LED

Type: 3 LED

LED	Description
10 (green)	10MB Mode
100 (green)	100MB Mode
ACT (yellow)	Active Transfer

Audio ESS Solo-1 ES-19385

The Solo-1™ ES1938 PCI AudioDrive solution implements a single-chip PCI audio solution, providing high-quality audio processing while maintaining full legacy DOS game compatibility. With playback dynamic range of 84dB, the Solo-1 complies with Microsoft® PC 98/PC 99 specifications and meets WHQL audio requirements. The Solo-1 forms a complete audio subsystem on a single chip for both add-in card and motherboard platforms.

The Solo-1 incorporates a microcontroller, ESFM™ music synthesizer, 3-D stereo effects processor, 16-bit stereo wave ADC and DAC, 16-bit stereo music DAC, MPU-401 UART mode serial port, dual game port, hardware master volume control, a serial port interface to external wavetable music synthesizer, DMA control logic with FIFO, and PCI bus interface logic. There are three stereo inputs (typically line-in, CD audio, and auxiliary line) and a mono microphone input.

The Solo-1 integrates ESS' field-proven hardware design for DOS game and compatibility with hardware FM synthesis (ESFM) and three methods for legacy audio control interface: PC/PCI, Distributed DMA, and Transparent DMA. Transparent DMA and Distributed DMA implement legacy compatibility with no sideband signals from PC core logic chipsets in addition to the standard PCI 2.1 bus. TDMA is compatible with Pentium®, Pentium Pro®, and Pentium® II chipsets.

Disabling the Audio Controller

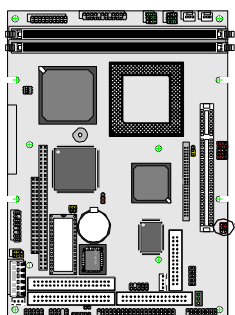

Connector : JSND
Type : onboard 3-pin header

State	JSND
Enabled	1-2
Disabled	2-3
default setting	

Serial Port COM2 Mode (RS-232/485)

The onboard COM2 port can be configured to operate either in RS-232C or RS-485 mode. Selection of the mode is done by jumper J2.

In RS-232C mode the onboard 10-pin header box JCOM2 is activated.
In RS-485 mode the 2-pin header RS1 should be used.

For pinout descriptions of COM2 and RS1 see page 23

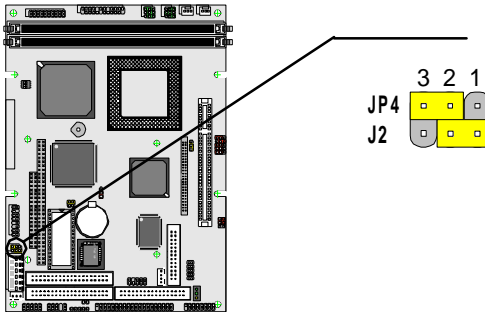

COM RS-232C/485 Selection (J2)

Connector : J2

Type : onboard 3-pin header

Mode	J2	Active Connector
RS-232C	1-2	JCOM2
RS-485	2-3	RS1

default setting

Switches and Indicators

JFRONT

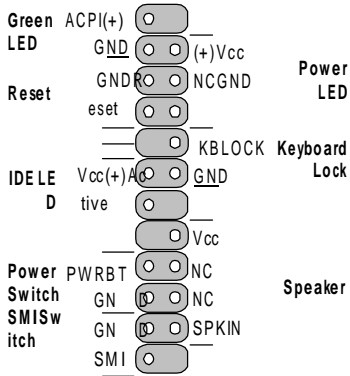
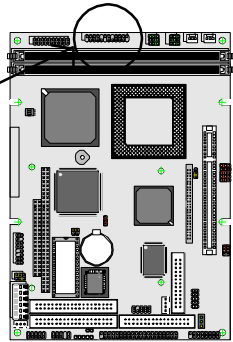

Note : (+) means LED anode

Interface Connectors HDD, FDD

Floppy Disk Drive (Floppy)

Connector : Floppy

Type : Onboard 34-pin box header

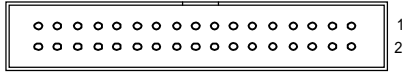

Pin	Description	Pin	Description
1	GROUND	2	REDUCE WRITE
3	GROUND	4	N/C
5	GROUND	6	N/C
7	GROUND	8	INDEX
9	GROUND	10	MOTOR ENABLE A
11	GROUND	12	DRIVE SELECT B
13	GROUND	14	DRIVE SELECT A
15	GROUND	16	MOTOR ENABLE B
17	GROUND	18	DIRECTION
19	GROUND	20	STEP
21	GROUND	22	WRITE DATA
23	GROUND	24	WRITE GATE
25	GROUND	26	TRACK 0
27	GROUND	28	WRITE PROTECT
29	GROUND	30	READ DATA
31	GROUND	32	HEAD SELECT
33	GROUND	34	DISK CHANGE

EIDE Connector (Primary_IDE, Secondary_IDE)

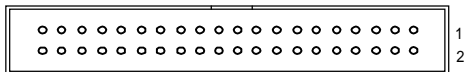

Connector : Primary_IDE and Secondary_IDE

Type : Two onboard 40-pin box headers, primary and secondary IDE

Pin	Description	Pin	Description
1	RESET IDE	2	GND
3	D7	4	D8
5	D6	6	D9
7	D5	8	D10
9	D4	10	D11
11	D3	12	D12
13	D2	14	D13
15	D1	16	D14
17	D0	18	D15
19	GND	20	NC
21	REQ	22	GND
23	IOW-	24	GND
25	IOR-	26	GND
27	IRDY	28	IDSEL
29	DACK-	30	GND
31	IRQ	32	NC
33	A1	34	GND
35	A0	36	A2
37	CS0	38	CS1
39	ACT-	40	GND

Peripheral Ports

Parallel Port (Print)

Connector : Print

Type : Onboard 26-pin box header

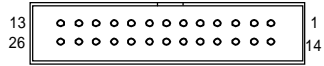

Pin	Description	Pin	Description
1	STROBE-	14	AUTOFEED-
2	DATA0	15	ERROR-
3	DATA1	16	INITIALIZE-
4	DATA2	17	SELECT INPUT-
5	DATA3	18	GND
6	DATA4	19	GND
7	DATA5	20	GND
8	DATA6	21	GND
9	DATA7	22	GND
10	ACKNOWLEDGE-	23	GND
11	BUSY	24	GND
12	PAPER EMPTY	25	GND
13	SELECT+	26	NC

USB Port (USB)

Connector : USB

Type : onboard 10-pin header for two USB ports

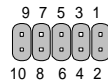

Pin	Description	Pin	Description
1	Vcc	2	Vcc
3	DATA0-	4	DATA1-
5	DATA0+	6	DATA1+
7	GND	8	GND
9	GND	10	GND

Onboard RS-232 Serial Port (JCOM1,2,3,4)

Connector : COM1, COM2, COM3, COM4
 Type : 4x onboard 10-pin headers

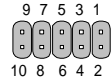

RS-232	Pin	Description	Pin	Description
	1	DCD	2	RXD
	3	TXD	4	DTR
	5	GND	6	DSR
	7	RTS	8	CTS
	9	RI	10	N/C

RS-485 Serial Ports (RS1)



Connector : RS1
 Type : onboard 2-pin header (COM2)

Pin	1	2
Description	RS-485+	RS-485-

IrDA (SIR)

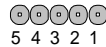

Connector : SIR
 Type : onboard 5-pin header

Pin	Description	Pin	Description
1	Vcc	2	N/C
3	IRRX	4	GND
5	IRTX		

16-bit General Purpose I/O (JDIO)



Connector : JDIO
 Type : Onboard 20-pin header

Digital input address (write) : 200H
 Digital output address (read) : 208H

Pin	Description	Pin	Description
1	DO0	2	DO1
3	DO2	4	DO3
5	DO4	6	DO5
7	DO6	8	DO7
9	DI0	10	DI1
11	DI2	12	DI3
13	DI4	14	DI5
15	DI6	16	DI7
17	GND	18	GND
19	+5V	20	+12V

Flat Panel VGA (LCD1)



Connector : LCD1

Type : Onboard 50-pin box header

Pin	Description	Pin	Description
1	+12V	2	+12V
3	GND	4	GND
5	VCC_LCD	6	ENAVDD
7	ENAVEE	8	GND
9	P0	10	P1
11	P2	12	P3
13	P4	14	P5
15	P6	16	P7
17	P8	18	P9
19	P10	20	P11
21	P12	22	P13
23	P14	24	P15
25	P16	26	P17
27	P18	28	P19
29	P20	30	P21
31	P22	32	P23
33	P24	34	P25
35	SHFCLK	36	FLM
37	M	38	LP
39	GND	40	ENABKL
41	P26	42	P27
43	P28	44	P29
45	P30	46	P31
47	P32	48	P33
49	P34	50	P35

CRT SVGA (VGAH)

Connector : VGAH

Type : onboard 16-pin header

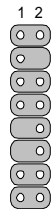

Pin	Description	Pin	Description
1	RED	2	GREEN
3	BLUE	4	N/C
5	GROUND	6	GROUND
7	GROUND	8	GROUND
9	N/C	10	GROUND
11	N/C	12	VDDAT
13	HSYNC	14	VSYSN
15	VDCCLK	16	N/C

PS/2 Keyboard (PS2-KB)

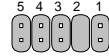

Connector : PS2-KB

Type : onboard 5-pin header

Pin	Description	Pin	Description
1	KBDATA	2	N/C
3	GND	4	Vcc
5	KBCLK	6	N/C

PS/2 Mouse (PS2-MS)



Connector : PS2-MS

Type : onboard 5-pin header

Pin	Description	Pin	Description
1	MSDATA	2	N/C
3	GND	4	Vcc
5	MSCLK	6	N/C

Audio Interface (JAUDIO)

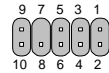

Connector : JAUDIO

Type : onboard 10-pin header

Pin	Description	Pin	Description
1	LINE RIGHT	2	GND
3	LINE LEFT	4	MIC
5	MIC	6	GND
7	N/C	8	SPEAKER LEFT
9	SPEAKER RIGHT	10	GND

CDROM audio interface (MITSUMI)



Connector : MITSUMI

Type : onboard 4-pin boxheader

Pin	Description	Pin	Description
1	GND	2	CDLEFT
3	GND	4	CDRIGHT

System Resources

Interrupt Assignment

IRQ Address	Description
0	System Timer
1	Keyboard (KB output buffer full)
2	Programmable Interrupt Controller
3	Serial Port 2
4	Serial Port 1
5	Parallel Port 2
6	Floppy controller
7	Parallel Port 1
8	Real-Time Clock
9	Software Redirected IRQ2
10	Reserved
11	Reserved
12	Reserved
13	Coprocessor
14	Primary IDE Controller
15	Secondary IDE Controller

Memory Mapping

Adress	Size	Description
00000000h-0009FFFFh	640K	Host access map to the main memory
000A0000h-000BFFFFh	128K	Reserved for Video frame buffer
000C0000h-000C3FFFh	16K	Reserved for VGA BIOS
000C4000h-000C7FFFh	16K	Reserved for VGA BIOS
000C8000h-000CBFFFh	16K	Reserved for ROM device
000CC000h-000CFFFFh	16K	Reserved for ROM device
000D0000h-000DFFFFh	64K	Reserved for ROM device

I/O Address Mapping

IO address	Description Notes
0000h-000Fh	DMA controller 1 registers
0010h-001Ch	Local Bus configuration registers
0020h-0021h	Interrupt controller 1 registers.
0040h-0043h	Timer/Counter registers
0060h-0064h	Keyboard shadow registers
0070h-0071h	NMI Mask control registers
0080h-008Fh	DMA Page registers.
0094h	Mother-board VGA enable
00A0h-00A1h	Interrupt controller 2 registers
00B1h	ISA standard Port B
00C0h-00DFh	DMA controller 2 registers
0102h	VGA setup register.
03B4h,03B5h,03BAh 03D4h,03D5h,03DAh 03C0h-03CFh	VGA registers.
0CF8h	PCI configuration Address register.
0CFCh-0CFFh	PCI configuration Data register.
46E8h	VGA add-in mode enable register.

SIS-530 AGP for CRT

3303449 only !

The board's SiS 530 embedded chipset incorporates SiS' popular 3D AGP solution that allows 3D acceleration at 100 MHz on a 64-bit internal host bus. With this architecture, the video data transfer rate achieves 800 MB/sec, far superior to the conventional 32-bit bus at 66 MHz.

Supported Display Modes :

Resolution	Colors	Refresh Rate
1600x1200	64K	60 Hz
1280x1024	16M	60, 75, 85 Hz
1024x768	16M	60, 75, 85 Hz
800x600	16M	60, 75, 85 Hz
640x480	16M	60, 75, 85 Hz

Memory Assignment

The SIS-530 shared memory architecture lets you assign up to 8 MB of SDRAM. Memory assignment is done in the boards "Integrated Peripherals" setup menu of the Award BIOS.

Important Notice !

Only system memory in DIMM socket 1 is available for sharing by the SIS-530 SVGA controller. This means that if only one DIMM is installed this always has to be the first DIMM socket.

C&T 69000 Flat Panel Controller

3303449C only !

The 69000 is the first member of CHIPS's HiQVideo family to integrate high speed SDRAM frame buffer memory into the chip. Using leading edge embedded memory logic technologies, the 69000 integrates 2 MBytes of SDRAM into the chip. By embedding SDRAM and graphics controller logic on the same die, the 69000 delivers uncompromised performance and at the same time consumes much less power than the discrete solution.

The integrated SDRAM supports up to 83MHz operation, which provides up to 664MBytes/second frame buffer bandwidth. The increase in the frame buffer bandwidth enables the 69000 to support high color, high-resolution graphics modes and real-time video acceleration.

Supported Display Modes :

Resolution	Colors	Refresh Rate
1280x1024	8bpp	60 Hz
1024x768	16bpp	60,75,85 Hz
800x600	24bpp	60,75,85 Hz
640x480	24bpp	60,75,85 Hz

Flat Panel Connector (LCD)



Pin assignment

The 3303449's Vcc is configurable as either +3.3 or +5.0 Volt by jumper setting

+12 V	1	2	+12 V
GND	3	4	GND
V _{CC}	5	6	ENA V _{DD}
FPV _{EE}	7	8	GND
P0	9	10	P1
P2	11	12	P3
P4	13	14	P5
P6	15	16	P7
P8	17	18	P9
P10	19	20	P11
P12	21	22	P13
P14	23	24	P15
P16	25	26	P17
P18	27	28	P19
P20	29	30	P21
P22	31	32	P23
P24	33	34	P25
SHFCLK	35	36	FLM
M	37	38	LP
GND	39	40	ENABKL
P26	41	42	P27
P28	43	44	P29
P30	45	46	P31
P32	47	48	P33
P34	49	50	P35

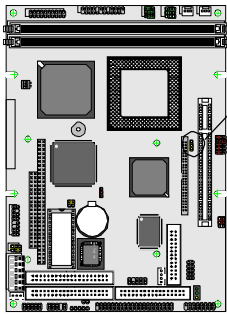
LCD Voltage Selection (JVOLT1)



JVOLT1
 1 
 2 
 3 

Connector : JVOLT1
 Type : onboard 3-pin header

Vcc	JVOLT1
+3.3	2-3
+5.0	1-2
default setting	

PLANAR EL640.480-AA1

Display type : 640 x 480 EL Mono

EL 640.480-AA1/ 34-pin 2.54 pitch / housing		3303449 / 50-pin 2.0 pitch / housing	
Pin	Description	Pin	Description
1	GND	39	GND
2	D0	21	PD12
3	GND	39	GND
4	D1	22	PD13
5	GND	39	GND
6	D2	23	PD14
7	N/C		
8	D3	24	PD15
9	N/C		
10	Reserved		
11	N/C		
12	Reserved		
13	N/C		
14	Reserved		
15	GND	39	GND
16	Reserved		
17	GND	3	GND
18	VCLK	35	SHFCLK
19	GND	3	GND
20	_BLANK	40	ENABKL
21	GND	3	GND
22	HS	38	LP
23	N/C		
24	VS	36	FLM
25	N/C		
26	N/C		
27	N/C		
28	ENABLE	6	PVCC
29	VMODE		
30	N/C		
31	N/C		
32	N/C		
33	Reserved		
34	Reserved		
J2(1)	+12Vdc	1	+12V
J2(2)	GND	4	GND
J2(3)	GND	4	GND
J2(4)	+5Vdc	5	VCC
J3(1)	LUM	5	VCC
J3(2)	GND	4	GND

KYOCERA KCB104VG2BA-A01

Display type : 640 x 480 16-bit Color STN

KCB104VG2BA-A01 Molex 53261-1510		3303449 / 50-pin 2.0 pitch / housing	
Pin	Description	Pin	Description
1	FLM	36	FLM
2	NC	---	---
3	DISP	40	ENABKL
4	LOAD	38	LP
5	VSS	39	GND
6	CP	35	SHFCLK
7	VSS	39	GND
8	HD0	20	P11
9	HD1	19	P10
10	HD2	18	P9
11	HD3	17	P8
12	HD4	12	P3
13	HD5	11	P2
14	HD6	10	P1
15	HD7	9	P0

KCB104VG2BA-A01 Molex 53261-1410		3303449 / 50-pin 2.0 pitch / housing	
Pin	Description	Pin	Description
1	LD0	24	P15
2	LD1	23	P14
3	LD2	22	P13
4	LD3	21	P12
5	LD4	16	P7
6	LD5	15	P6
7	LD6	14	P5
8	LD7	13	P4
9	VDD	5	+5V
10	VSS	3	GND
11	NC	---	---
12	NC	---	---
13	NC	---	---
14	VCONT	---	+0.8~+2.8V

SHARP LQ12S41

Display type : 800 x 600 18-bit Color TFT

LQ12S41 DF9X-41S-1V/Hirose		3303449 / 50-pin 2.0 pitch / housing	
Pin	Description	Pin	Description
1	GND	39	GND
2	CLK	35	SHFCLK
3	GND	39	GND
4	Hsync	38	LP
5	Vsync	36	FLM
6	GND	39	GND
7	GND	39	GND
8	GND	39	GND
9	R0	27	P18
10	R1	28	P19
11	R2	29	P20
12	GND	4	GND
13	R3	30	P21
14	R4	31	P22
15	R5	32	P23
16	GND	4	GND
17	GND	4	GND
18	GND	4	GND
19	G0	19	P10
20	G1	20	P11
21	G2	21	P12
22	GND	8	GND
23	G3	22	P13
24	G4	23	P14
25	G5	24	P15
26	GND	8	GND
27	GND	8	GND
28	GND	8	GND
29	B0	11	P2
30	B1	12	P3
31	B2	13	P4
32	GND	3	GND
33	B3	14	P5
34	B4	15	P6
35	B5	16	P7
36	GND	3	GND
37	DE	37	M
38	R/L	---	---
39	VCC	5	+3.3V
40	VCC	5	+3.3V
41	U/P	---	---

HITACHI LMG9211XUCC

Display type : 640 x 480 16-bit Color STN

LMG9211XUCC Molex 53261-1510		3303449 / 50-pin 2.0 pitch / housing	
Pin	Description	Pin	Description
1	FLM	36	FLM
2	NC	---	---
3	DISP-OFF	40	ENABKL
4	LOAD	38	LP
5	VSS	39	GND
6	CP	35	SHFCLK
7	VSS	39	GND
8	UD0	20	P11
9	UD1	19	P10
10	UD2	18	P9
11	UD3	17	P8
12	UD4	12	P3
13	UD5	11	P2
14	UD6	10	P1
15	UD7	9	P0

LMG9211XUCC Molex 53261-1410		3303449 / 50-pin 2.0 pitch / housing	
Pin	Description	Pin	Description
1	LD0	24	P15
2	LD1	23	P14
3	LD2	22	P13
4	LD3	21	P12
5	LD4	16	P7
6	LD5	15	P6
7	LD6	14	P5
8	LD7	13	P4
9	VDD	5	+5V
10	VSS	3	GND
11	VSS	3	GND
12	VEE	---	+27V
13	VEE	---	+27V
14	VO	---	+27V

NAN YA LTBSHT024GC

Display type : 640 x 480 8-bit Mono STN

LTBSHT024GC
Molex 53261-1590

3303449 / 50-pin
2.0 pitch / housing

Pin	Description	Pin	Description
1	FLM	36	FLM
2	LOAD	38	LP
3	CP	35	SHFCLK
4	D.OFF	40	ENABKL
5	VDD	5	VCC
6	VSS	39	GND
7	VEE	--	-17V
8	DU0	12	P3
9	DU1	11	P2
10	DU2	10	P1
11	DU3	9	P0
12	DL0	16	P7
13	DL1	15	P6
14	DL2	14	P5
15	DL3	13	P4

TORISAN MXS121022010

Display type : 800 x 600 18-bit Color TFT

MXS121022010 DF9X-41S-1V/Hirose		3303449 / 50-pin 2.0 pitch / housing	
Pin	Description	Pin	Description
1	GND	3	GND
2	DCLK	35	SHFCLK
3	GND	3	GND
4	Hsync	38	LP
5	Vsync	36	FLM
6	GND	3	GND
7	GND	3	GND
8	GND	3	GND
9	R0	27	P18
10	R1	28	P19
11	R2	29	P20
12	GND	4	GND
13	R3	30	P21
14	R4	31	P22
15	R5	32	P23
16	GND	4	GND
17	GND	4	GND
18	GND	4	GND
19	G0	19	P10
20	G1	20	P11
21	G2	21	P12
22	GND	8	GND
23	G3	22	P13
24	G4	23	P14
25	G5	24	P15
26	GND	8	GND
27	GND	8	GND
28	GND	8	GND
29	B0	11	P2
30	B1	12	P3
31	B2	13	P4
32	GND	39	GND
33	B3	14	P5
34	B4	15	P6
35	B5	16	P7
36	GND	39	GND
37	DE	37	M
38	TEST	39	GND
39	VCC	5	+3.3V
40	VCC	5	+3.3V
41	MODE	---	---

NEC NL8060AC26-04

Display type : 800 x 600 18-bit Color TFT

NL8060AC26-04 DF9X-41S-1V/Hirose		3303449 / 50-pin 2.0 pitch / housing	
Pin	Description	Pin	Description
1	GND	39	GND
2	CLK	35	SHFCLK
3	GND	39	GND
4	Hsync	38	LP
5	Vsync	36	FLM
6	GND	39	GND
7	GND	39	GND
8	GND	39	GND
9	R0	27	P18
10	R1	28	P19
11	R2	29	P20
12	GND	4	GND
13	R3	30	P21
14	R4	31	P22
15	R5	32	P23
16	GND	4	GND
17	GND	4	GND
18	GND	4	GND
19	G0	19	P10
20	G1	20	P11
21	G2	21	P12
22	GND	8	GND
23	G3	22	P13
24	G4	23	P14
25	G5	24	P15
26	GND	8	GND
27	GND	8	GND
28	GND	8	GND
29	B0	11	P2
30	B1	12	P3
31	B2	13	P4
32	GND	3	GND
33	B3	14	P5
34	B4	15	P6
35	B5	16	P7
36	GND	3	GND
37	DE	37	M
38	VCC	5	+3.3V/+5V
39	VCC	5	+3.3V/+5V
40	VCC	5	+3.3V/+5V
41	MODE	---	---

This page intentionally left blank

AWARD BIOS Setup

The 3303449 uses the Award PCI/ISA BIOS for the system configuration. The Award BIOS setup program is designed to provide the maximum flexibility in configuring the system by offering various options which could be selected for end-user requirements. This chapter is written to assist you in the proper usage of these features.

To access AWARD PCI/ISA BIOS Setup program, press key. The Main Menu will be displayed at this time.

ROM PCI/ISA BIOS (2A5IMTPD)
CMOS SETUP UTILITYAWARD
SOFTWARE, INC.

STANDARD CMOS SETUP	HARDWARE MONITOR
BIOS FEATURES SETUP	INTEGRATED PERIPHERALS
CHIPSET FEATURES SETUP	SUPERVISOR PASSWORD
POWER MANAGEMENT SETUP	USER PASSWORD
PNP/PCI CONFIGURATION	IDE HDD AUTO DETECTION
LOAD BIOS DEFAULTS	SAVE & EXIT SETUP
LOAD SETUP DEFAULTS	EXIT WITOUT SAVE
Esc: Quit	↑↓→← : Select Item
F10: Save & Exit Setup	(Shift)F2: Change Color
Time, Date, Hard Disk Type	

-
2. Select USER and enter values into each drive parameter field.
 3. Use the IDE HDD AUTO DETECTION function in Setup.

Here is a brief explanation of drive specifications:

Type: The BIOS contains a table of pre-defined drive types. Each defined drive type has a specified number of cylinders, number of heads, write precompensation factor, landing zone, and number of sectors. Drives whose specifications do not accommodate any pre-defined type are classified as type USER.

Size: Disk drive capacity (approximate). Note that this size is usually slightly greater than the size of a formatted disk given by a disk-checking program.

Cyls: Number of cylinders

Head: Number of heads

Precomp: Write precompensation cylinder

Landz: Landing zone

Sector: Number of sectors

Mode: Auto, Normal, large, or LBA

Auto

The BIOS automatically determines the optimal mode.

Normal

Maximum number of cylinders, heads, and sectors supported are 1024, 16, and 63.

Large

For drives that do not support LBA and have more than 1024 cylinders. Applicable to only a few drives.

LBA

Logical Block Addressing. During drive accesses, the IDE controller transforms the data address described by sector, head, and cylinder number into a physical block address, significantly improving data transfer rates. For drives with greater than 1024 cylinders.

Drive A, B

Select the correct specifications for the diskette drive(s) installed in the computer.

None :	No diskette drive installed
360K :	5.25 in5-1/4 inch PC-type standard drive
1.2M :	5.25 in5-1/4 inch AT-type high-density drive
720K :	3.5 in3-1/2 inch double-sided drive
1.44M :	3.5 in3-1/2 inch double-sided drive
2.88M :	3.5 in3-1/2 inch double-sided drive

Floppy Mode 3 Support

Enables support for 1.2 MB format capacity on 3½" disk drives.

This format is commonly used Japan.

Video Select the type of primary video subsystem in your computer. The BIOS usually detects the correct video type automatically. The BIOS supports a secondary video subsystem, but you do not select it in Setup.

Halt On During the power-on self-test (POST), the computer stops if the BIOS detects a hardware error. You can tell the BIOS to ignore certain errors during POST and continue the boot-up process. These are the selections:

No errors	POST does not stop for any errors.
All errors	If the BIOS detects any non-fatal error, POST stops and prompts you to take corrective action.
All, But Keyboard	POST does not stop for a keyboard error, but stops for all other errors.
All, But Diskette	POST does not stop for diskette drive errors, but stops for all other errors.
All, But Disk/Key	POST does not stop for a keyboard or disk error, but stops for all other errors.

BIOS Features Setup

ROM PCI/ISA BIOS (2A5IMTPD)			
STANDARD CMOS SETUP			
AWARD SOFTWARE, INC.			
Virus Warning	:	Disabled	Video BIOS Shadow : Enabled
CPU Internal Cache	:	Enabled	C8000-CBFFF Shadow : Disabled
External Cache	:	Enabled	CC000-CFFFF Shadow : Disabled
Quick Power On Self Test	:	Disabled	D0000-D3FFF Shadow : Disabled
Boot Sequence	:	A,C,SCSI	D4000-D7FFF Shadow : Disabled
Swap Floppy Drive	:	Disabled	D8000-DBFFF Shadow : Disabled
Boot Up Floppy Seek	:	Enabled	DC000-DFFFF Shadow : Disabled
Boot Up NumLock Status	:	On	Cyrix 6x86/MII CPUID : Enabled
Memory Parity Check	:	Disabled	
Typematic Rate Setting	:	Disabled	
Typematic Rate (Char/Sec)	:	6	
Typematic Delay (Msec)	:	250	
Security Option	:	Setup	
PCI/VGA Palette Snoop	:	Disabled	
OS Select for DRAM > 64MB	:	Non-OS2	
Report No FDD For Win95	:	Yes	
		Esc: Quit ↑↓→← : Select Item	
		F1: Help PU/PD/+/- : Modify	
		F5: Old Values (Shift)F2: Color	
		F6: Load BIOS Defaults	
		F7: Load Setup Defaults	

Virus Warning

When enabled, you receive a warning message if a program (specifically, a virus) attempts to write to the boot sector or the partition table of the hard disk drive. You should then run an anti-virus program. Keep in mind that this feature protects only the boot sector, not the entire hard drive.

CPU Internal Cache & CPU External Cache

Cache memory is additional memory that is much faster than conventional DRAM (system memory). CPUs from 486-type on up contain internal cache memory, and most, but not all, modern PCs have additional (external) cache memory. When the CPU requests data, the system transfers the requested data from the main DRAM into cache memory, for even faster access by the CPU.

Quick Power On Self Test

Select Enabled to reduce the amount of time required to run the power-on self-test (POST). A quick POST skips certain steps. We recommend that you normally disable quick POST. Better to find a problem during POST than lose data during your work.

Boot Sequence

The original IBM PCs loaded the DOS operating system from drive A (floppy disk), so IBM PC-compatible systems are designed to search for an operating system first on drive A, and then on drive C (hard disk). However, modern computers usually load the operating system from the hard drive, and may even load it from a CD-ROM drive.

Swap Floppy Drive

This field is effective only in systems with two floppy drives. Selecting Enabled assigns physical drive B to logical drive A, and physical drive A to logical drive B.

Boot Up Floppy Seek

When Enabled, the BIOS tests (seeks) floppy drives to determine whether they have 40 or 80 tracks. Only 360-KB floppy drives have 40 tracks; drives with 720 KB, 1.2 MB, and 1.44 MB capacity all have 80 tracks. Because very few modern PCs have 40-track floppy drives, we recommend that you set this field to Disabled to save time.

Boot Up NumLock Status

Toggle between On or Off to control the state of the NumLock key when the system boots. When toggled On, the numeric keypad generates numbers instead of controlling cursor operations.

Memory Parity Check

Parity is a measure of the consistency of your system's RAM, memory chips. Plus, there is both parity and non-parity memory. At boot, the Award BIOS both sizes and tests all memory. Normally, when a parity error is detected, the BIOS will display a message describing the problem as well as the problem's location, if possible. The boot process will then terminate and you will not be able to continue until the bad chip or SIMM is located and replaced.

Disabling the Memory Parity Check allows the system to by-pass the test and allow your system to boot. You then have a choice of continuing to operate your system or attempting the remedying the problem.

Typematic Rate Setting

When Disabled, the following two items (Typematic Rate and Typematic Delay) are irrelevant. Keystrokes repeat at a rate determined by the keyboard controller in your system. When Enabled, you can select a typematic rate and typematic delay.

Typematic Rate (Chars/Sec)

When the typematic rate setting is enabled, you can select a typematic rate (the rate at which character repeats when you hold down a key) of 6, 8, 10, 12, 15, 20, 24 or 30 characters per second.

Typematic Delay (Msec)

When the typematic rate setting is enabled, you can select a typematic delay (the delay before key strokes begin to repeat) of 250, 500, 750 or 1000 milliseconds.

Security Option

If you have set a password, select whether the password is required every time the System boots, or only when you enter Setup.

System The system will not boot and access to Setup will be denied if the correct password is not entered at the prompt.

Setup The system will boot, but access to Setup will be denied if the correct password is not entered at the prompt.

Note: To disable security, select PASSWORD SETTING at Main Menu and then you will be asked to enter password. Do not type anything and just press Enter, it will disable security. Once the security is disabled, the system will boot and you can enter Setup freely.

PCI/VGA Palette Snoop

Normally this option is always disabled !

Nonstandard VGA display adapters such as overlay cards or MPEG video cards may not show colors properly. Setting "PCI/VGA Palette Snoop" to Enable should correct this problem. If the PCI/VGA Palette Snoop is "Enabled", any I/O access on the ISA-bus to the VGA card's palette registers will be reflected on the PCI bus. This will allow overlay cards to adapt to the changing palette colors.

OS Select for DRAM > 64MB

Non-OS/2 If your operating system is not OS/2

OS/2 If system DRAM is more than 64MB and if your operating system is OS/2.

Report No FDD For WIN 95

Select Yes to release IRQ6 when the system contains no floppy drive, for compatibility with Windows 95 logo certification. In the "Integrated Peripherals" menu screen, select Disabled for the Onboard FDC Controller field.

Video BIOS Shadow

Enabled this copies the video BIOS from ROM to RAM. effectively enhancing performance, and reducing the amount of upper memory available by 32KB (the C000~C7FFF area of memory between 640 KB and 1 MB is used).

C8000-CBFFF Shadow

Enabling any of the C8000~DFFFF segments allows components to move their firmware into these upper memory segments. However your computer can lock-up doing so, because some devices don't like being shadowed at those particular 16 KB segments of upper memory.

Note - In Windows 95, double click 'Computer' within Device Manager and select 'Memory'. This will tell you what segments (if any) are being shadowed For DOS you can use MSD.EXE to see what segments are claimed.

CC000-CFFFF - D0000-D3FFF - D4000-D7FFF - D8000-DBFFF and DC000-DFFFF - Same as above.

Cyrix 6x86/MII CPUID

When using a Cyrix CPU this option should be enabled to correctly determine the Cyrix CPU type.

Chipset Features Setup

ROM PCI/ISA BIOS (2A5IMTPD)			
CHIPSET FEATURES SETUP			
AWARD SOFTWARE, INC.			
Refresh Rate Control	: 15.6us	Video BIOS Cachable	: Enabled
Ref/Act Command delay	: 6T	Memory Hole at 15/16M	: Enabled
Refresh Queue Depth	: 12	PCI Post Write Buffer	: Disabled
RAS Precharge Time	: 3T	PCI Delayed Transaction	: Disabled
RAS to CAS Delay	: 3T		
ISA Bus Clock Frequency	: PCICLK/4		
Starting Point of Paging	: 1T		
NA# Enable	: Disabled		
L2 Cache Burst RD Cycle	: Delay 1T		
Asyn/Sync Mode CPU DRAM	: Asynchron		
SDRAM CAS Latency	: 3T		
SDRAM WR Retite Rate	: X-2-2-2		
DRAM Opt RAS Precharge	: Disabled		
PCI Peer Concurrency	: Disabled		
Read Prefetch Memory RD	: Enabled		
Assert TRDY After Prefet	: 2 QWs	Esc: Quit	↑↓→← : Select Item
CPU to PCI Burst Mem. WR	: Disabled	F1: Help	PU/PD/+/- : Modify
CPU to PCI Post Write	: Disabled	F5: Old Values (Shift)	F2: Color
AGP Aperture Size	: 64MB	F6: Load BIOS Defaults	
System BIOS Cacheable	: Enabled	F7: Load Setup Defaults	

This Chipset Feature Setup screen allows you to configure the system based on the specific features of the installed chipset. This chipset manages bus speeds and access to system memory resources, such as DRAM and the external cache. It also coordinates communications between the conventional ISA bus and the PCI bus. It must be stated that these items should never need to be altered. The default settings have been chosen because they provide the best operating conditions for your system. The only time you might consider making any changes would be if you discovered that data was being lost while using your system. The first chipset settings deal with CPU access to dynamic random access memory (DRAM). The default timings have been carefully chosen and should only be altered if data is being lost. Such a scenario might well occur if your system had mixed speed DRAM chips installed so that greater delays may be required to preserve the integrity of the data held in the slower memory chips.

Refresh Rate Control

Select the period required to refresh the DRAMs, according to DRAM specifications.

Ref / Act Command Delay

Set the DRAM clock of the refresh command to refresh/active command delay.

Refresh Queue Depth

Set the depth of refresh queue.

RAS Precharge Time

The precharge time is the number of cycles it takes for the RAS to accumulate its charge before DRAM refreshes. If insufficient time is allowed, refresh may be incomplete and the DRAM may fail to retain data.

The Choice: 2T, 3T, 4T, 5T.

RAS to CAS Delay

When DRAM is refreshed, both rows and columns are addressed separately. This setup item allows you to determine the timing of the transition from RAS (row address strobe) to CAS (column address strobe).

The choice: 2T, 3T, 4T, 5T.

ISA Bus Clock Frequency

You can set the speed of the AT bus at one-third or one-fourth of the CPU clock speed. The choice: 7.159MHz, PCICLK/3, PCICLK/4.

Starting Point of Paging

This value controls the start timing of memory paging operations.

The choice: 1T, 2T, 4T, 8T.

NA# Enable

Selecting Enabled permits pipelining, in which the chipset signals the CPU for a new memory address before all data transfers for the current cycle are complete, resulting in faster performance. The choice: Enabled, Disabled.

L2 Cache Burst RD Cycle

These timing numbers are the pattern of cycles the CPU uses to read data from the cache. The choice: Normal, Delay 1T.

Asyn/Sync Mode CPU/DRAM

This feature can only be enabled when the frequency of CPU clock and the frequency of DRAM clock are the same and the skew between these two clocks should be zero. The choice: Asynchronous, Synchronous.

SDRAM CAS Latency

When synchronous DRAM is installed, the number of clock cycles of CAS latency depends on the DRAM timing. Do not reset this field from the default value specified by the system designer. The choice: 2T, 3T.

SDRAM WR Retire Rate

The system designer must select the correct timing for data transfers from the write buffer to memory, according to DRAM specifications

The choice: 0WS, 1WS.

DRAM Opt RAS Precharge

The precharge time is the number of cycles it takes for the RAS to accumulate its charge before DRAM refreshes. If insufficient time is allowed, refresh may be incomplete and the DRAM may fail to retain data. The choice: Enabled, Disabled.

PCI Peer Concurrency

Peer concurrency means that more than one PCI device can be active at a time. The choice: Enabled, Disabled.

Read Prefetch Memory RD

When this item is Enabled, the system is allowed to prefetch the next read instruction and initiate the next process. The choice: Enabled, Disabled.

Assert TRDY After Prefet

When you select 1QWs, SiS530 asserts its first TRDY# for 1 transaction after it prefetched 1 quadword of data from system memory. Otherwise, SiS530 asserts its first TRDY# after 2 quadwords are prefetched.

The choice: 1QWs, 2QWs.

CPU to PCI Burst Mem. WR

Select enabled permits PCI burst memory write cycles, for faster performance. When disabled, performance is slightly slower, but more reliable.

Choices are Enabled, Disabled.

CPU to PCI Post Write

Select enabled to use a fast buffer for posting writes to memory. Using a fast buffer releases the CPU before completion of a write cycle to DRAM.

The choice: Enabled, Disabled.

AGP Aperture Size (MB)

Select the size of the Accelerated Graphics Port (AGP) aperture. The aperture is a portion of the PCI memory address range dedicated for graphics memory address space. Host cycles that hit the aperture range are forwarded to the AGP without any translation. See www.agpforum.org for APG information.

The choice: 4 MB, 8MB, 16 MB, 32 MB, 64 MB, 128 MB, 256MB.

System BIOS Cacheable

Selecting Enabled allows caching of the system BIOS ROM at F0000h-FFFFFh, resulting in better system performance. However, if any program writes to this memory area, a system error may result. The choice: Enabled, Disabled.

Video BIOS Cacheable

Selecting Enabled allows caching of the system BIOS ROM at C0000h-F7FFFh, resulting in better system performance. However, if any program writes to this memory area, a system error may result. The choice: Enabled, Disabled.

Memory Hole at 15M-16M

You can reserve this area of system memory for ISA adapter ROM. When this area is reserved, it cannot be cached. The user information of peripherals that need to use this area of system memory usually discusses their memory requirements. The choice: Enabled, Disabled.

PCI Post Write Buffer

Enable/disable PCI post write buffer.

PCI Delayed Transaction

The chipset has an embedded 32-bit posted write buffer to support delay transactions cycles. Select Enabled to support compliance with PCI specification version 2.1. The choice: Enabled, Disabled.

Power Management Setup

ROM PCI/ISA BIOS (2A5IMTPD) POWER MANAGEMENT SETUP AWARD SOFTWARE, INC.	
ACPI Function : Enabled Power Management : User Define Video Off Option : Always On Video Off Method : V/H SYNC+Blank Switch Function : Break/WakeDoze Speed (div by) : 2/8 Stdby Speed (div by) : 1/8 Modem Use IRQ : 3 Hot Key Function As : Poer Off ** PM Timers ** HDD Off After : 15 Min Doze Mode : 4 Hours Standby Mode : 4 Hours Suspend Mode : 4 Hours ** PM Events ** HDD Ports Activity : Enabled COM Ports Activity : Enabled LPT Ports Activity : Enabled	VGA Activity : Enabled IRQ [3-7,9-15], NMI : Enabled IRQ 8 Break Suspend : Disabled Esc: Quit ↑↓→← : Select Item F1 : Help PU/PD/+/- : Modify F5 : Old Values (Shift)F2: Color F6 : Load BIOS Defaults F7 : Load Setup Defaults

ACPI Function

Select Enabled only if your computer's operating system supports the Advanced Configuration and Power Interface (ACPI) specification. Currently, Windows 98 and Windows NT 5.0 (beta) support ACPI.

Power Management

There are 4 selections for Power Management, 3 of which have fixed mode :

- Disable (default)** No power management. Disables all four modes

Min. Power Saving Minimum power management. Doze Mode = 1 hr. Standby Mode = 1 hr., Suspend Mode = 1 hr., and HDD Power Down = 15 min.
- Max. Power Saving** Maximum power management -- ONLY AVAILABLE FOR SL CPU'S. Doze Mode = 1 min., Standby Mode = 1 min., Suspend Mode = 1 min., and HDD Power Down = 1 min.
- User Defined** Allows you to set each mode individually. When not disabled, each of the ranges are from 1 min. to 1 hr. except for HDD Power Down which ranges from 1 min. to 15 min. and disable.

Video Off Option

When enabled, this feature allows the VGA adapter to operate in a power saving mode. This determines the manner in which the monitor is blanked.

-
- Always On Monitor will remain on during power saving modes.
- Suspend --> Off Monitor blanked when the systems enters the Suspend mode.
- Susp,Stby --> Off Monitor blanked when the system enters either Suspend or Standby modes.
- All Modes --> Off Monitor blanked when the system enters any power saving mode.

Video Off Method

This determines the manner in which the monitor is blanked.

V/H SYNC+Blank causes the system to turn off the vertical and horizontal synchronization ports and write blanks to the video buffer.

Blank Screen This option only writes blanks to the video buffer.

DPMS Initial display power management signaling.

Switch Function

You can choose whether or not to permit your system to enter complete Suspend mode. Suspend mode offers greater power savings, with a correspondingly longer awakening period. The choice: Deturbo, Break, Break/Wake, Disabled.

Doze Speed (div by)

Sets the CPU's speed during Doze mode. The speed is reduced to a fraction of the CPU's normal speed. The divisors range from 1 to 8 The choice: 1~8.

Stdby Speed (div by)

Select a divisor to reduce the CPU speed during Standby mode to a fraction of the full CPU speed. The speed is reduced to a fraction of the CPU's normal speed. The divisors range from 1 to 8-0. The choice: 1~8

Modem Use IRQ

Name the interrupt request (IRQ) line assigned to the modem (if any) on your system. Activity of the selected IRQ always awakens the system.

Hot Key Function As

Select Enabled if your system has a hot key for soft power off.
The choice: Enabled, Disabled.

PM Timers

The following four modes are Green PC power saving functions which are only user configurable when User Defined Power Management has been selected. See above for available selections.

HDD Off After

By default, this item is Disabled, meaning that no matter the mode the rest of the system, the hard drive will remain ready. Otherwise, you have a range of choices from 1 to 15 minutes or Suspend. This means that you can elect to have your hard disk drive be turned off after a selected number of minutes or when the rest of the system goes into a Suspend mode.

Doze Mode

When enabled and after the set time of system inactivity, the CPU clock will run at slower speed while all other devices still operate at full speed.

Standby Mode

When enabled and after the set time of system inactivity, the fixed disk drive and the video would be shut off while all other devices still operate at full speed.

Suspend Mode

When enabled and after the set time of system inactivity, all devices except the CPU will be shut off.

PM Events

You may disable activity monitoring of some common I/O events and interrupt requests so they do not wake up the system. The default wake-up event is keyboard activity.

When On (or named, in the case of LPT & COM), any activity from one of the listed system peripheral devices or IRQs wakes up the system.

HDD Ports Activity

When set to On (default), any event occurring at a HDD (serial) port will awaken a system which has been powered down.

COM Port Activity

When set to On (default), any event occurring at a hard or floppy drive port will awaken a system which has been powered down.

LPT Port Activity

When set to On (default), any event occurring at a LPT (printer) port will awaken a system which has been powered down.

VGA Activity

When set to On (default), any event occurring at VGA will awaken a system which has been powered down.

IRQ [3-7, 9-15], NMI

The following is a list of IRQ's, Interrupt ReQuests, which can be exempted much as the COM ports and LPT ports above can. When an I/O device wants to gain the attention of the operating system, it signals this by causing an IRQ to occur. When the operating system is ready to respond to the request, it interrupts itself and performs the service. As above, the choices are On and Off. When set On, activity will neither prevent the system from going into a power management mode nor awaken it.

IRQ 8 Break Suspend

You can Enable or Disable monitoring of IRQ8 (the Real Time Clock) so it does not awaken the system from Suspend mode.

PNP/PCI Configuration

ROM PCI/ISA BIOS (2A5IMTPD)	
PNP/PCI CONFIGURATION	
AWARD SOFTWARE, INC.	
Resources Controlled By : Manual	PCI IRQ Activated By : Level
Reset Configuration Data : Disabled	
IRQ-3 assigned to : PCI/ISA Pnp	
IRQ-4 assigned to : PCI/ISA Pnp	
IRQ-5 assigned to : PCI/ISA Pnp	
IRQ-7 assigned to : PCI/ISA Pnp	
IRQ-9 assigned to : PCI/ISA Pnp	
IRQ-10 assigned to : PCI/ISA Pnp	
IRQ-11 assigned to : PCI/ISA Pnp	
IRQ-12 assigned to : PCI/ISA Pnp	
IRQ-14 assigned to : PCI/ISA Pnp	
IRQ-15 assigned to : PCI/ISA Pnp	
DMA-0 assigned to : PCI/ISA Pnp	
DMA-1 assigned to : PCI/ISA Pnp	
DMA-3 assigned to : PCI/ISA Pnp	Esc: Quit ↑↓→← : Select Item
DMA-5 assigned to : PCI/ISA Pnp	F1: Help PU/PD/+- : Modify
DMA-6 assigned to : PCI/ISA Pnp	F5: Old Values (Shift) F2: Color
DMA-7 assigned to : PCI/ISA Pnp	F6: Load BIOS Defaults
	F7: Load Setup Defaults

This section describes configuring the PCI bus system. PCI, or Personal Computer Interconnect, is a system which allows I/O devices to operate at speeds nearing the speed the CPU itself uses when communicating with its own special components.

Resources Controlled By

The Award Plug and Play BIOS can automatically configure all the boot and Plug and Play-compatible devices. If you select Auto, all the interrupt request (IRQ) and DMA assignment fields disappear, as the BIOS automatically assigns them. Choice: Auto and Manual.

Reset Configuration Data

Normally, you leave this field Disabled. Select Enabled to reset Extended System Configuration Data (ESCD) when you exit Setup if you have installed a new add-on and the system reconfiguration has caused such a serious conflict that the operating system cannot boot. Choice: Enabled and Disabled.

IRQ n Assigned to

When resources are controlled manually, assign each system interrupt as one of the following types, depending on the type of device using the interrupt:

- Legacy ISA Devices compliant with the original PC AT bus specification, requiring a specific interrupt (such as IRQ4 for serial port 1).
- PCI/ISA PnP Devices compliant with the Plug and Play standard, whether designed for PCI or ISA bus architecture.

DMA n Assigned to

When resources are controlled manually, assign each system DMA channel as one of the following types, depending on the type of device using the interrupt:

- Legacy ISA Devices compliant with the original PC AT bus specification, requiring a specific DMA channel
- PC/ISA PnP Devices compliant with the Plug and Play standard, whether designed for PCI or ISA bus architecture.

PCI IRQ Activated By

This sets the method by which the PCI bus recognizes that an IRQ service is being requested by a device. Under all circumstances, you should retain the default configuration unless advised otherwise by your system's manufacturer.

The choice: Level, Edge.

Hardware Monitor

ROM PCI/ISA BIOS (2A5IMTPD) CPU FEATURE SETUP AWARD SOFTWARE, INC.	
Current CPU Temperature : 40°C/104°F Current CPUFAN1 Speed : 0 RPM +12(V) : 12.49 V Vcc(V) : 5.12 V Vio(V) : 3.42 V Vcore(V) 2.22 V	
	Esc: Quit ↑↓→← : Select Item F1 : Help PU/PD/+/- : Modify F5 : Old Values (Shift)F2: Color F6 : Load BIOS Defaults F7 : Load Setup Defaults

Current CPU Temperature

A onboard sensor underneath the CPU monitors the current CPU temperature.

Current CPU Fan Speed

When using the onboard CPU Fan power connector the board can deduct the actual rounds per minute (RPM) of the installed CPU Fan

+12(V)

Measured external power for Serial port, FAN etc should be ~ +12 V

V_{CC}(V)

Measured external power supply to board should be ~ +5 V

V_{IO}(V)

Measured power to DIMM, Chipset and Slot 1 Cache, should be ~ 3.5 V

V_{CORE}(V)

Measured power to CPU core, depends on type of CPU and jumper settings

Integrated Peripherals (3303449 version)

ROM PCI/ISA BIOS (2A5IMTPD) INTEGRATED PERIPHERALS AWARD SOFTWARE, INC.			
Internal PCI/IDE	: Both IDE	Onboard Parallel Mode	: ECP
Primary Master PIO	: Auto IDE	ECP Mode Use DMA	: 3
Primary Slave PIO	: Auto IDE	Onboard Serial Port 3	: 3E8H
Secondary Master PIO	: Auto IDE	Serial Port 3 Use IRQ	: IRQ11
Secondary Slave PIO	: Auto	Onboard Serial Port 4	: 2E8H
Primary Master UltraDMA	: Auto	Serial Port 4 Use IRQ	: IRQ10
Primary Slave UltraDMA	: Auto	PS/2 mouse function	: Enabled
Secondary Master UltraDMA	: Auto	USB Controller	: Enabled
Secondary Slave UltraDMA	: Auto IDE	USB Keyboard Support	: Disabled
Burst Mode	: Enabled	Init Display First	: PCI Slot
IDE Data Port Post Write	: Disabled	VGA Shared Memory Size	: 4 MB
IDE HDD Block Mode	: Enabled		
Onboard FDD Controller	: Enabled		
Onboard Serial Port 1	: 3F8/IRQ4		
Onboard Serial Port 2	: 2F8/IRQ3	Esc: Quit	↑↓→← : Select Item
IR Address Select	: 3E8H	F1: Help	PU/PD/+/- : Modify
IR Mode	: ASKIR	F5: Old Values (Shift)	F2: Color
IR IRQ Select	: IRQ10	F6: Load BIOS Defaults	
Onboard Parallel Port	: Disabled	F7: Load Setup Defaults	

Integrated Peripherals (3303449C version)

ROM PCI/ISA BIOS (2A5IMTPD) INTEGRATED PERIPHERALS AWARD SOFTWARE, INC.			
Internal PCI/IDE	: Both IDE	Onboard Parallel Mode	: ECP
Primary Master PIO	: Auto IDE	ECP Mode Use DMA	: 3
Primary Slave PIO	: Auto IDE	Onboard Serial Port 3	: 3E8H
Secondary Master PIO	: Auto IDE	Serial Port 3 Use IRQ	: IRQ11
Secondary Slave PIO	: Auto	Onboard Serial Port 4	: 2E8H
Primary Master UltraDMA	: Auto	Serial Port 4 Use IRQ	: IRQ10
Primary Slave UltraDMA	: Auto	PS/2 mouse function	: Enabled
Secondary Master UltraDMA	: Auto	USB Controller	: Enabled
Secondary Slave UltraDMA	: Auto IDE	USB Keyboard Support	: Disabled
Burst Mode	: Enabled	Init Display First	: PCI Slot
IDE Data Port Post Write	: Disabled	LCD Panel Type	: Panel 0
IDE HDD Block Mode	: Enabled		
Onboard FDD Controller	: Enabled		
Onboard Serial Port 1	: 3F8/IRQ4	Esc: Quit	↑↓→← : Select Item
Onboard Serial Port 2	: 2F8/IRQ3	F1: Help	PU/PD/+/- : Modify
IR Address Select	: 3E8H	F5: Old Values (Shift)	F2: Color
IR Mode	: ASKIR	F6: Load BIOS Defaults	
IR IRQ Select	: IRQ10	F7: Load Setup Defaults	
Onboard Parallel Port	: Disabled		

Internal PCI / IDE

This chipset contains an internal PCI IDE interface with support for two IDE channels. The choice: Primary, Secondary, Both.

IDE Primary/Secondary Master/Slave PIO

The four IDE PIO (Programmed Input / Output) fields let you set a PIO mode (0-4) for each of the four IDE devices that the onboard IDE interface supports. Modes 0 through 4 provide successively increased performance. In Auto mode, the system automatically determines the best mode for each device. The choice: Auto, Mode 0, Mode 1, Mode 2, Mode 3, Mode 4.

IDE Primary/Secondary Master/Slave UDMA

UDMA (Ultra DMA) is a DMA data transfer protocol that utilizes ATA commands and the ATA bus to allow DMA commands to transfer data at a maximum burst rate of 33 MB/s. When you select Auto in the four IDE UDMA fields (for each of up to four IDE devices that the internal PCI IDE interface supports), the system automatically determines the optimal data transfer rate for each IDE device. The choice: Auto, Mode 0, Mode 1, Mode 2, Mode 3, Mode 4.

IDE Burst Mode

Selecting Enabled reduces latency between each drive read/write cycle, but may cause instability in IDE subsystems that cannot support such fast performance. If you are getting disk drive errors, try setting this value to Disabled. This field does not appear when the Internal PCI/IDE field, above, is Disabled. The choice: Enabled, Disabled.

IDE Data Port Post Write

Selecting Enabled speeds up processing of drive reads and writes, but may cause instability in IDE subsystems that cannot support such fast performance. If you are getting disk drive errors, try setting this value to Disabled. The choice: Enabled, Disabled.

IDE HDD Block Mode

The chipset contains a PCI IDE interface with support for two IDE channels. Select Enabled to activate the primary and/or secondary IDE interface. Select Disabled to deactivate this interface, if you install a primary and/or secondary add-in IDE interface. Enabled : Secondary HDD controller used. Disabled : Secondary HDD controller not used.

Onboard FDD Controller

This should be enabled if your system has a floppy disk drive (FDD) installed on the system board and you wish to use it. Even when so equipped, if you add a higher performance controller, you will need to disable this feature. The choice: Enabled, Disabled.

Onboard Serial Port 1/Port 2

This item allows you to determine access onboard serial port 1/port 2 controller with which I/O address. The choice: 3F8/IRQ4, 2E8/IRQ3, 3E8/IRQ4, 2F8/IRQ3, Disabled, Auto.

IR Address Select

This item allows you to determine access onboard IR port controller with which I/O address. The choice: 3F8, 2E8, 3E8, 2F8 and Disabled.

IR Mode

Offers a selection of two different types of infrared ports.

IrDA : Standard Infra Red Port

ASKIR : Amplitude Shift Keyed Infrared Port

IR IRQ Select

Select Interrupt for IR port. Options 3, 4, 10, 11.

Onboard Parallel Port

Select a logical LPT port name and matching address for the physical parallel (printer) port.

Parallel Port Mode

Select an operating mode for the onboard parallel (printer) port. Select SPP unless you are certain your hardware and software both support one of the other available modes. The choice: SPP, EPP, ECP, ECP+E PP.

ECP Mode Use DMA

Select a DMA channel for the parallel port for use during ECP mode.

The choice: 3, 1.

Onboard Serial Port 3/Port 4

This item allows you to determine access onboard serial port 3 / port 4 controller with which I/O address. The choice for both ports

I/O Address: 3F8/2E8/3E8/2F8, IRQ : 3/4/10/11

PS/2 mouse function

If your system has a PS/2 mouse port and you install a serial pointing device, select Disabled. The choice: Enabled, Disabled.

USB Controller

Select Enabled if your system contains a Universal Serial Bus (USB) controller and you have USB peripherals. The choice: Enabled, Disabled.

USB Keyboard Support

Choice enable, disable.

Init Display First

This item allows you to decide to active which bus first (PCI Slot or AGP first). The choice: PCI Slot, AGP.

VGA Shared Memory Size (3303449 only !)

Specify the size of system memory to allocate for video memory, from 1 MB to 8 MB. The choice: 1MB, 2MB, 4MB, 8MB.

POST Codes

During the power-on self test (POST), the BIOS either sounds a beep code or displays a message when it detects a correctable error. An error message may be followed by a prompt to press F1 to continue or press DEL to enter Setup.

Audible Error Messages

Currently the only implemented beep code indicates that a video error has occurred and the BIOS cannot initialize the video screen to display any additional information. This beep code consists of a single long beep followed by two short beeps.

Visible Error Messages

BIOS ROM checksum error - System halted

The checksum of the BIOS code in the BIOS chip is incorrect, indicating the BIOS code may have become corrupt. Contact your system dealer to replace the BIOS.

CMOS battery failed

CMOS battery is no longer functional. Contact your system dealer for a replacement battery.

CMOS checksum error - Defaults loaded

Checksum of CMOS is incorrect, so the system loads the default equipment configuration. A checksum error may indicate that CMOS has become corrupt. This error may have been caused by a weak battery. Check the battery and replace if necessary.

CPU at nnnn

Displays the running speed of the CPU.

Display switch is set incorrectly

The display switch on the motherboard can be set to either monochrome or color. This message indicates the switch is set to a different setting than indicated in Setup. Determine which setting is correct, and then either turn off the system and change the jumper, or enter Setup and change the VIDEO selection.

Press ESC to skip memory test

The user may press Esc to skip the full memory test.

Floppy disk(s) fail

Cannot find or initialize the floppy drive controller or the drive. Make sure the controller is installed correctly. If no floppy drives are installed, be sure the Diskette Drive selection in Setup is set to NONE or AUTO.

HARD DISK initializing

Please wait a moment...

Some hard drives require extra time to initialize.

HARD DISK INSTALL FAILURE

Cannot find or initialize the hard drive controller or the drive. Make sure the controller is installed correctly. If no hard drives are installed, be sure the Hard Drive selection in Setup is set to NONE.

Hard disk(s) diagnosis fail

The system may run specific disk diagnostic routines. This message appears if one or more hard disks return an error when the diagnostics run.

Keyboard error or no keyboard present

Cannot initialize the keyboard. Make sure the keyboard is attached correctly and no keys are pressed during POST. To purposely configure the system without a keyboard, set the error halt condition in Setup to HALT ON ALL, BUT KEYBOARD. The BIOS then ignores the missing keyboard during POST.

Keyboard is locked out - Unlock the key

This message usually indicates that one or more keys have been pressed during the keyboard tests. Be sure no objects are resting on the keyboard.

Memory Test :

This message displays during a full memory test, counting down the memory areas being tested.

Memory test fail

If POST detects an error during memory testing, additional information appears giving specifics about the type and location of the memory error.

Override enabled - Defaults loaded

If the system cannot boot using the current CMOS configuration, the BIOS can override the current configuration is a set of BIOS defaults designed for the most stable, minimal-performance system operations.

Press TAB to show POST screen

System OEMs may replace the Award BIOS POST display with their own proprietary display. Including this message in the OEM display permits the operator to switch between the OEM display and the default POST display.

Primary master hard disk fail

POST detects an error in the primary master IDE hard drive.

Primary slave hard disk fail

POST detects an error in the secondary master IDE hard drive.

Secondary master hard disk fail

POST detects an error in the primary slave IDE hard drive.

Secondary slave hard disk fail

POST detects an error in the secondary slave IDE hard drive.

POST Card Error Messages

The following codes are not displayed on the screen. They can only be viewed on the LED display of a so called POST card. The codes are listed in the same order as the according functions are executed at PC startup. If you have access to a POST Card reader, you can watch the system perform each test by the value that's displayed. If the system hangs (if there's a problem) the last value displayed will give you a good idea where and what went wrong, or what's bad on the system board.

CODE	CHECK	DESCRIPTION OF CHECK
C0	Turn Off Chipset	OEM Specific-Cache control Cache
01	Processor Test 1	Processor Status (1FLAGS) Verification. Tests the following processor status flags:carry, zero, sign, overflow, The BIOS sets each flag, verifies they are set, then turns each flag off and verifies it is off.
02	Processor Test 2	Read/Write/Verify all CPU registers except SS, SP, and BP with data pattern FF and 00.
03	Initialize Chips	Disable NMI, PIE, AIE, UEI, SQWV Disable video, parity checking, DMA Reset math coprocessor Clear all page registers, CMOS shut-down byte Initialize timer 0, 1, and 2, including set EISA timer to a known state Initialize DMA controllers 0 and 1 Initialize interrupt controllers 0 and 1 Initialize EISA extended registers.
04	Test Memory Refresh Toggle	RAM must be periodically refreshed to keep the memory from decaying. This function ensures that the memory refresh function is working properly.
05	Blank video Initialize keyboard	Keyboard controller initialization
06	Reserved	
07	Test CMOS Interface and Battery Status	Verifies CMOS is working correctly, detects bad battery.
BE	Chipset Default Initialization	Program chipset registers with power on BIOS defaults.

C1	Memory presence test	OEM Specific-Test to size on-board memory
C5	Early Shadow	OEM Specific-Early Shadow enable for fast boot.
C6	Cache presence test	External cache size detection
08	Setup low memory	Early chip set initialization Memory presence test OEM chip set routines Clear low 64K of memory Test first 64K memory.
09	Early Cache Initialization	Cyrix CPU initialization Cache initialization
0A	Setup Interrupt Vector Table	Initialize first 120 interrupt vectors with SPURIOUS_INT_HDLR and initialize INT 00h-1Fh according to INT_TBL
0B	Test CMOS RAM Checksum	Test CMOS RAM Checksum, if bad, or insert key pressed, load defaults.
0C	Initialize keyboard	Detect type of keyboard controller (optional) Set NUM_LOCK status.
0D	Initialize Video Interface	Detect CPU clock. Read CMOS location 14h to find out type of video in use. Detect and Initialize Video Adapter.
0E	Test Video Memory	Test video memory, write sign-on message to screen. Setup shadow RAM - Enable shadow according to Setup.
0F	Test DMA Controller 0	BIOS checksum test. Keyboard detect and initialization
10	Test DMA Controller 1	
11	Test DMA Page Registers	Test DMA Page Registers.
12-13	Reserved	

14	Test Timer Counter 2	Test 8254 Timer 0 Counter 2
15	Test 8259-1 Mask Bits	Verify 8259 Channel 1 masked interrupts by alternately turning off and on the interrupt lines.
16	Test 8259-2 Mask Bits	Verify 8259 Channel 2 masked interrupts by alternately turning off and on the interrupt lines.
17	Test Stuck 8259's Interrupt Bits	Turn off interrupts then verify no interrupt mask register is on.
18	Test 8259 Interrupt Functionality	Force an interrupt and verify the interrupt occurred.
19	Test Stuck NMI Bits (Parity/IO Check)	Verify NMI can be cleared.
1A		Display CPU clock
1B-1E	Reserved	
1F	Set EISA Mode	If EISA non-volatile memory checksum is good, execute EISA initialization. If not, execute ISA tests and clear EISA mode flag. Test EISA Configuration Memory Integrity (checksum & communication interface).
20	Enable Slot 0	Initialize slot 0 (System Board).
21-2F	Enable Slots 1-15	Initialize slots 1 through 15.
30	Size Base and Extended Memory	Size base memory from 256K to 640K and extended memory above 1MB.
31	Test Base and Extended Memory	Test base memory from 256K to 640K and extended memory above 1MB using various patterns. NOTE: This test is skipped in EISA mode and can be skipped with ESC key in ISA mode.

32	Test EISA Extended Memory	If EISA Mode flag is set then test EISA memory found in slots initialization. NOTE: This test is skipped in ISA mode and can be skipped with ESC key in EISA mode.
33-3B	Reserved	
3C		Setup Enabled
3D	Initialize & Install Mouse	Detect if mouse is present, initialize mouse, install interrupt vectors.
3E	Setup Cache Controller	Initialize cache controller.
3F	Reserved	
BF	Chipset Initialization	Program chipset registers with Setup values
40		Display virus protect disable or enable
41	Initialize Floppy Drive & Controller	Initialize floppy disk drive controller and any drives.
42	Initialize Hard Drive & Controller	initialize hard drive controller and any drives.
43	Detect & Initialize Serial/Parallel Ports	Initialize any serial and parallel ports (also game port).
44	Reserved	
45	Detect & Initialize Math Coprocessor	Initialize math coprocessor.
46	Reserved	
47	Reserved	
48-4D	Reserved	
4E	Manufacturing POST Loop Display Messages	Reboot if Manufacturing POST Loop pin or is set. Otherwise display any messages (i.e., any non-fatal errors that were detected during POST) and enter Setup.

4F	Security Check	Ask password security (optional).
50	Write CMOS	Write all CMOS values back to RAM and clear screen.
51	Pre-boot Enable	Enable parity checker Enable NMI, Enable cache before boot.
52	Initialize Option ROMs	Initialize any option ROMs present from C8000h to EFFFFh. NOTE: When FSCAN option is enabled, ROMs initialize from C8000h to F7FFFh.
53	Initialize Time Value	Initialize time value in 40h: BIOS area.
60	Setup Virus Protect	Setup virus protect according to Setup
61	Set Boot Speed	Set system speed for boot
62	Setup NumLock	Setup NumLock status according to Setup
63	Boot Attempt	Set low stack Boot via INT 19h.
B0	Spurious	If interrupt occurs in protected mode.
B1	Unclaimed NMI	If unmasked NMI occurs, display: Press F1 to disable NMI, F2 reboot.
E1-EF	Setup Pages	E1- Page 1, E2 - Page 2, etc.
FF	Boot	

Howto : Flash the BIOS

What do you need:

To flash your BIOS you'll need

- 1) a xxxxx.bin file that is a file image of the new BIOS
- 2) AWDFLASH.EXE a utility that can write the data-file into the BIOS chip.

The procedure:

Create a new, clean DOS (6 or higher) bootable floppy with "format a: /s".

Copy flash utility and the BIOS image file to this disk.

Turn your computer off. Insert the floppy you just created and boot the computer. As it boots up, hit the [DEL] key to enter the CMOS setup. Go to "LOAD SETUP (or BIOS) DEFAULTS," and then save and exit the setup program. Continue to boot with the floppy disk.

Type "AWDFLASH" to execute the flash utility. When prompted, enter the name of the new BIOS image and begin the flash procedure. Note: If you reboot now, you may not be able to boot again.

After the flash utility is complete, reboot the system.

Warranty

This product is warranted to be in good working order for a period of one year from the date of purchase. Should this product fail to be in good working order at any time during this period, we will, at our option, replace or repair it at no additional charge except as set forth in the following terms. This warranty does not apply to products damaged by misuse, modifications, accident or disaster.

Vendor assumes no liability for any damages, lost profits, lost savings or any other incidental or consequential damage resulting from the use, misuse of, or inability to use this product. Vendor will not be liable for any claim made by any other related party.

Return authorization must be obtained from the vendor before returned merchandise will be accepted. Authorization can be obtained by calling or faxing the vendor and requesting a Return Merchandise Authorization (RMA) number. Returned goods should always be accompanied by a clear problem description.

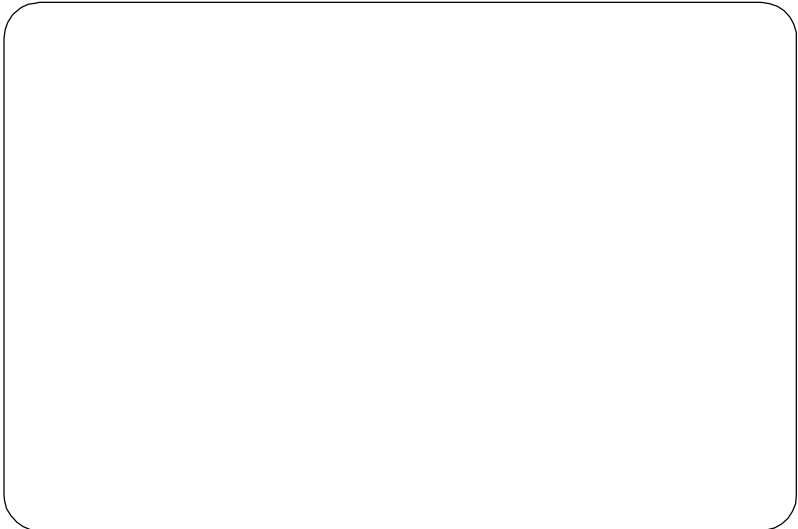

Any advice or comments about our products and service, or anything we can help you with please don't hesitate to contact with us. We will do our best to support you for your products, projects and business

Global American Inc.

Address	17 Hampshire Drive Hudson, NH 03051
TEL	Toll Free (U.S. Only) 800-833-8999 (603)886-3900
FAX	(603)886-4545
Website	http://www.globalamericaninc.com
E-Mail	salesinfo@globalamericaninc.com

