



User's Manual

3301860

Table of Contents

0. PREFACE	2
0.1 COPYRIGHT NOTICE AND DISCLAIMER	2
0.2 WELCOME TO THE 3301860 CPU BOARD.....	2
0.3 BEFORE YOU USE THIS GUIDE	2
0.4 RETURNING YOUR BOARD FOR SERVICE.....	2
0.5 TECHNICAL SUPPORT AND USER COMMENTS	3
0.6 STATIC ELECTRICITY PRECAUTIONS	3
1. INTRODUCTION	4
1.1 PACKING LIST.....	4
1.2 SPECIFICATIONS.....	5
1.3 BLOCK DIAGRAM.....	6
2. INSTALLATION	7
2.1 3301860'S BOARD DIMENSIONS	7
2.2 CPU INSTALLATION	9
2.3 MEMORY INSTALLATION.....	10
3. CONNECTION	11
3.1 PS2 KEYBOARD & MOUSE KBMS1	11
3.2 USB CONNECTOR USB1	11
3.3 EXTERNAL USB HEADER USB3.....	12
3.4 PARALLEL PORT CONNECTOR LPT1.....	12
3.5 SERIAL PORT CONNECTOR COM1.....	13
3.6 EXTERNAL SERIAL PORT HEADER COM2-COM6.....	13
3.7 VGA CONNECTOR VGA1.....	14
3.8 RJ- 45 & USB CONNECTOR CN2.....	14
3.9 DVI-D CONNECTOR CN1.....	15
3.10 AUDIO LINE OUT LINE IN MIC HEADER J4.....	15
3.11 CD IN HEADER J6.....	15
3.12 HARD DISK IDE CONNECTOR (IDE1, IDE2)	16
3.13 COMPACT FLASH CONNECTOR CFB1.....	18
3.14 COMPACT FLASH CONNECTOR MASTER SLAVE SELECT HEADER JP3.....	19
3.15 CPU CLOCK SELECT HEADER JCLK1.....	19
3.16 INTERNAL BUZZER BZ1.....	19
3.17 CPU FAN POWER CONNECTOR FAN1, FAN2, FAN3.....	19
3.18 COMS BATTERY HEADER JBAT1.....	20
3.19 18, 24 BITS LVDS CONNECTOR LCD1, LCD4.....	20
3.20 LVDS INTERVER CONNECTOR J7, JJ1.....	21
3.21 LCD PANEL TYPE SELECT S1.....	22
3.22 DDR SDRAM SOCKET DIMM1, DIMM2.....	22
3.23 MINI PCI SLOT MPCIB1.....	22
3.24 PCI SLOT PCI1.....	22
3.25 PCI SELECT HEADER JP2.....	22
3.26 ATX ATX_12V POWER CONNECTOR ATX1, PW1.....	23
3.27 PANEL HEADER J1.....	23
4. WATCHDOG TIMER CONFIGURATION	24
4.1 WATCHDOG TIMER SETTING	24
5. BIOS CONSOLE	25
5.1 MAIN SETUP.....	25
5.2 ADVANCED CHIPSET SETUP	27
5.3 POWER SETUP	28
5.4 PERIPHERALS SETUP	29
5.5 PNP/PCI SETUP	30
5.6 PC HEALTH SETUP	31
5.7 BOOT SETUP	32
5.8 EXIT SETUP.....	33
5.9 BIOS UPDATE	34
APPENDIX A. ADDRESS MAPPING	35
IO ADDRESS MAP.....	35
MEMORY MAP.....	35
APPENDIX B. INTERRUPT REQUEST (IRQ)	36

0. PREFACE

0.1 COPYRIGHT NOTICE AND DISCLAIMER

This document is copyrighted, 2002, by Global American, Inc. All rights are reserved. No part of this manual may be reproduced, copied, transcribed, stored in a retrieval system, or translated into any language or computer language in any form or by any means, such as electronic, mechanical, magnetic, optical, chemical, manual or other means without the prior written permission or original manufacturer.

Global American, Inc. assumes no responsibility or warranty with respect to the content in this manual and specifically disclaims any implied warranty of merchantability or fitness for any particular purpose. Furthermore, Global American, Inc. reserves the right to make improvements to the products described in this manual at any times without notice. Such revisions will be posted on the Internet (WWW.GLOBALAMERICANINC.COM) as soon as possible.

Possession, use, or copy of the software described in this publication is authorized only pursuant to valid written license from Global American, Inc. or an authorized sub licensor.

ACKNOWLEDGEMENTS

AMI, IBM PC/AT, ALI, Windows 3.1, MS-DOS...are registered trademarks.

All other trademarks and registered trademarks are the property of their respective owners.

0.2 WELCOME TO THE 3301860 CPU BOARD

This guide introduces the Global American, Inc. 3301860 CPU Board.

Use information provided in this manual describes this card's functions and features. It also helps you start, set up and operate your 3301860. General system information can also be found in this publication.

0.3 BEFORE YOU USE THIS GUIDE

Please refer to the Chapter 3, "Setting System," in this guide, if you have not already installed this 3301860. Check the packing list before you install and make sure the accessories are completely included.

3301860 CD provides the newest information regarding the CPU card. Please refer to the files of the enclosed utility CD. It contains the modification and hardware & software information, and adding the description or modification of product function after manual printed.

0.4 RETURNING YOUR BOARD FOR SERVICE

If your board requires any services, contact the distributor or sales representative from whom you purchased the product for service information. If you need to ship your board to us for service, be sure it is packed in a protective carton. We recommend that you keep the original shipping container for this purpose.

You can help assure efficient servicing for your product by following these guidelines:

1. Include your name, address, daytime telephone, facsimile number and E-mail.
2. A description of the system configuration and/or software at the time of malfunction.
3. A brief description of the problem occurred.

0.5 TECHNICAL SUPPORT AND USER COMMENTS

Users comments are always welcome as they assist us in improving the quality of our products and the readability of our publications. They create a very important part of the input used for product enhancement and revision.

We may use and distribute any of the information you provide in any way appropriate without incurring any obligation. You may, of course, continue to use the information you provide.

If you have any suggestions for improving particular sections or if you find any errors on it, please send your comments to Global American, Inc. or your local sales representative and indicate the manual title and book number.

0.6 STATIC ELECTRICITY PRECAUTIONS

Before removing the board from its anti-static bag, read this section about static electricity precautions. Static electricity is a constant danger to computer systems. The charge that can build up in your body may be more than sufficient to damage integrated circuits on any PC board. It is, therefore, important to observe basic precautions whenever you use or handle computer components. Although areas with humid climates are much less prone to static build-up, it is always best to safeguard against accidents that may result in expensive repairs. The following measures should be sufficient to protect your equipment from static discharge:

- „ Touch a grounded metal object to discharge the static electricity in your body (or ideally, wear a grounded wrist strap).
- „ When unpacking and handling the board or other system components, place all materials on an anti-static surface.
- „ Be careful not to touch the components on the board, especially the “golden finger” connectors on the bottom of the board.

1. INTRODUCTION

Welcome to the 3301860 Embedded ATX Single Board Computer. The 3301860 Pentium® M embedded board incorporates the Intel® advanced 855GME Chipset that supports processors from 600MHz to 2.0MHz in 479-ball Micro-FCBGA package with a front size bus of 400MHz.

Graphics display functionality is provided by the ATI mobility chipset VGA controller that supports CRT display and LVDS interface with 24-bit panel specifications. Ethernet connectivity comes from the ICH4-integrated Ethernet 10/100 Ethernet controller.

Two DDR DIMM sockets supports up to 2GB of memory. Two Serial ports are supported. There are two IDE connectors – IDE1 supporting UDMA33/66/100 and IDE2 with UDMA33 while supporting a CF Type II socket for its slave channel.

Other I/O features include four USB ports connector and two USB port using pin headers. Expansion slots composed of one PCI and one Mini PCI slot. 3301860 uses a 20-pin ATX power and a 4 pin +12V input connector.

1.1 PACKING LIST

In addition to this *User's Manual*, the 3301860 package includes the following items:

- „ The quick setup manual
- „ 3301860 Embedded ATX Single Board
- „ Software utility CD x 1
- „ 5.25" IDE HDD ATA 100Cable x 1
- „ 2.5" IDE HDD Cable x 1
- „ Serial port Cable x 1
- „ Audio interface Cable x 1
- „ USB port Cable x 1
- „ Serial port Y Cable

1.2 SPECIFICATIONS

Model Name	3301860
CPU Type	Intel Pentium M Processor, Ultra Low Voltage, at HFM core frequency of 600MHz ~ 2.0GHz (Socket 478)
CPU Voltage	0.700 ~ 1.708V
CPU Frequency	400MHz
Chipset	GMCH : Intel 82855GME, 732-pin Micro-FCBGA ICH4 : Intel 82801DB, 421-pin BGA, FWH
BIOS	Award BIOS, support ACPI function
Cache	1M Level 2 cache
Display	GRAPHICS : ATI Mobility RADEON 9000 1. Support CRT D-SUB 15-pin female connector 2. Support One LVDS interface (DF13 Socket, Max 24bit) 3. Support DVI-D 24pin female connector
LAN	ICH4 integrated LAN controller (10/100Mb) + Phy Intel 85856ET&RJ45 connector
Audio	ICH4 Built-in Sound controller + AC97 code ALC202A 2 channel (Line-out, Line-in, MIC.) pin header (2x6pin, pitch 2.54mm)
Memory Type	2 x DDR 184-pin DIMM 2.5V(DDR200/266/333MHz), Max. capacity 2GB
LPC I/O	Winbond 83627HF 1. Support Parallel Port x 1 (D-SUB 25-pin) 2. Support series Port x 2 (COM1 : D-SUB 9-pin, COM2 : pin header 2x5-pin pitch 2.0) 3. Support Hardware monitor Fintek F81216DG Support series port x 4 (COM3,COM4 : pin header 2x10-pin pitch 2.0, COM5,COM6 : pin header 2x10-pin pitch 2.0)
RTC/CMOS	ICH4 Built-in
Battery	Lithium Battery
KB&MS Controller	Winbond 83627HF built-in keyboard & mouse controller (PS2 &6-pin MINI-DIN)
IDE	ICH4 Built-in 1. IDE1, 40-pin box header (UDMA 33/66/100) 2. IDE2, 44-pin box header (UDMA 33)
Compact Flash	Type II, using IDE2 channel
USB	6 port, USB 2.0/1.1, (Rear I/O panel) ,& 2x10-pin header pitch 2.54mm
WatchDog Timer	0~60sec
Power Connector	20-pin ATX Power input + The Pentium 4 ATX power include another 2x2 pin+12V input connector
Expansion Slots	PCI slot x1, MiniPCI slot x1
Form factor	240x190mm

1.3 BLOCK DIAGRAM

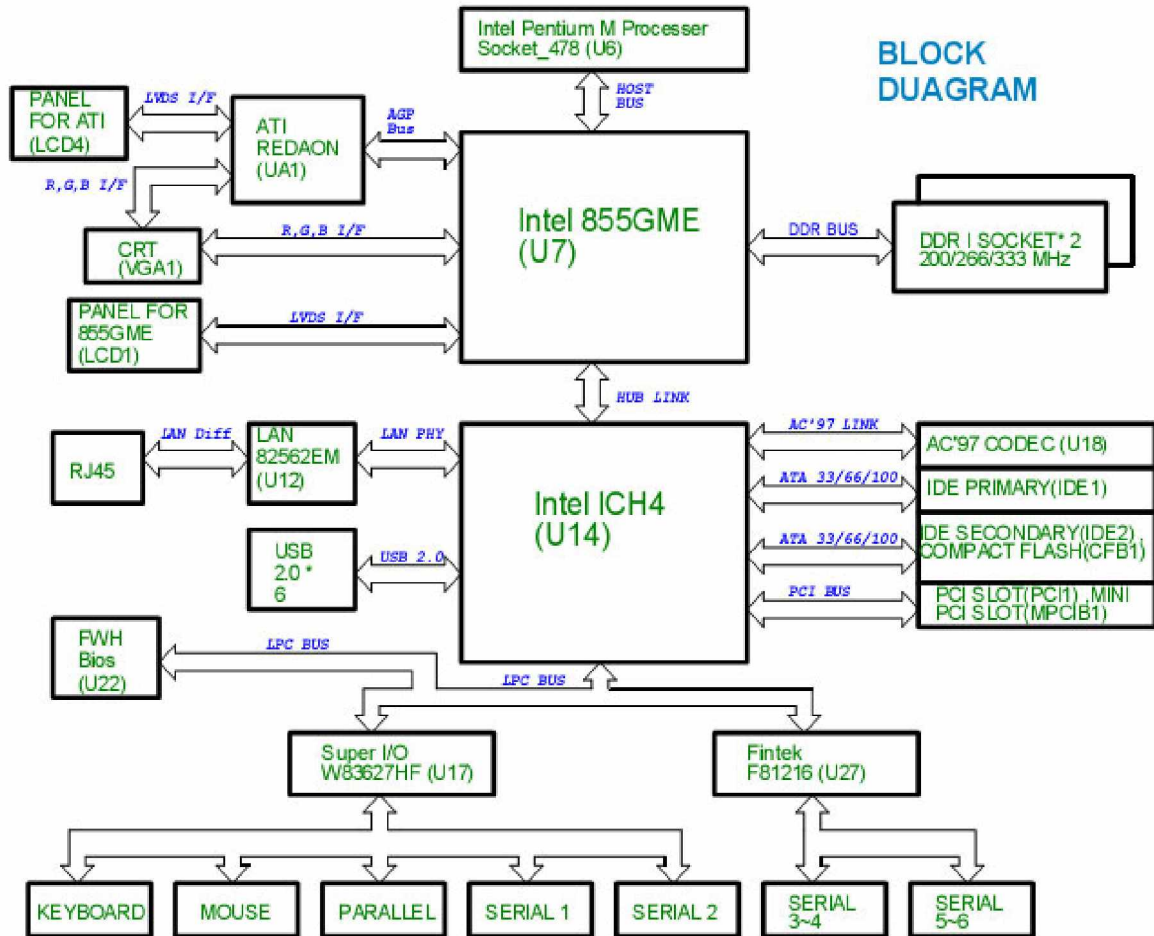

2. INSTALLATION

This chapter describes how to install the 3301860. At first, the layout of 3301860 is shown, and the unpacking information that you should be careful is described. The jumpers and switches setting for the 3301860's configuration are as below.

2.1 3301860'S BOARD DIMENSIONS

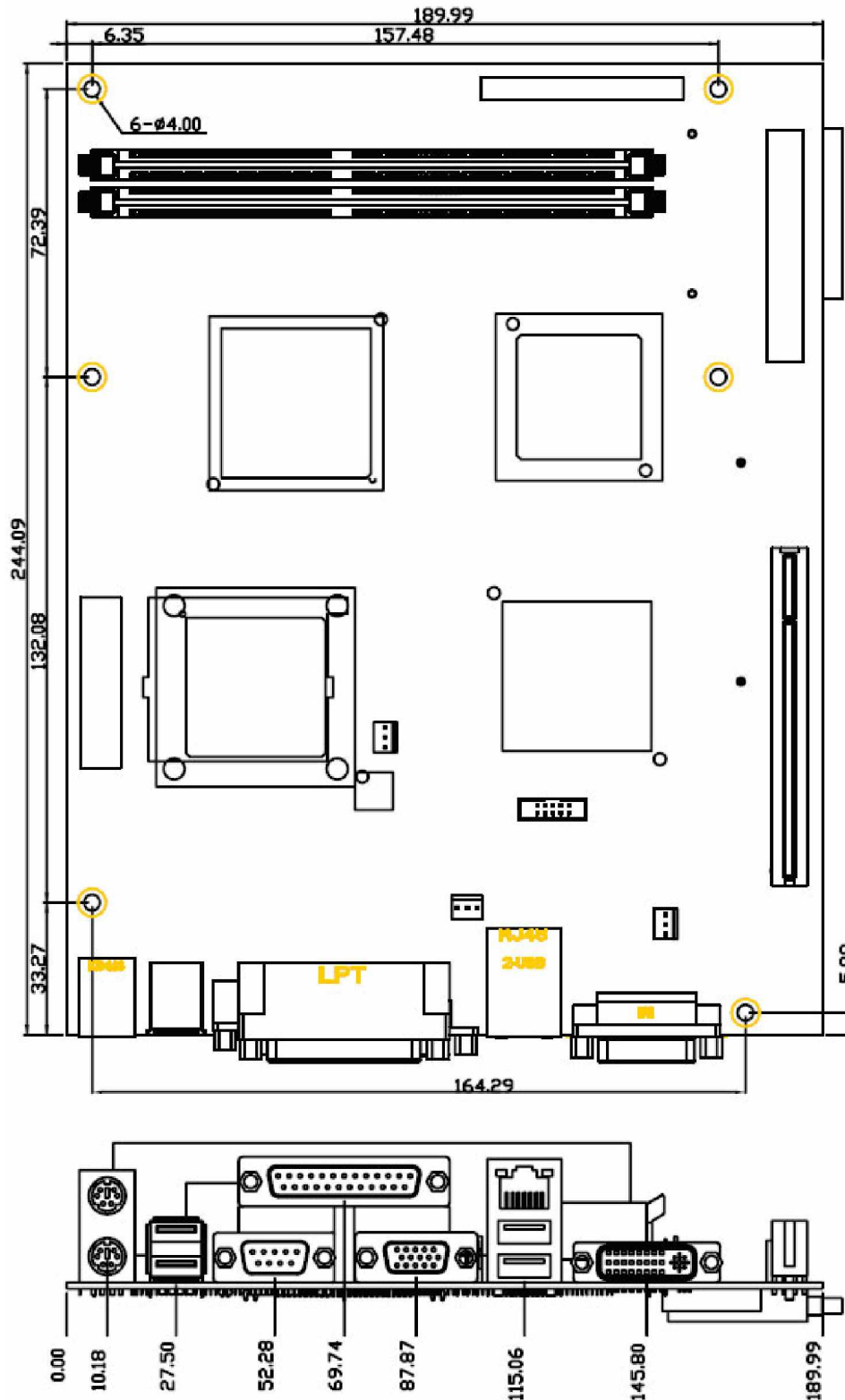

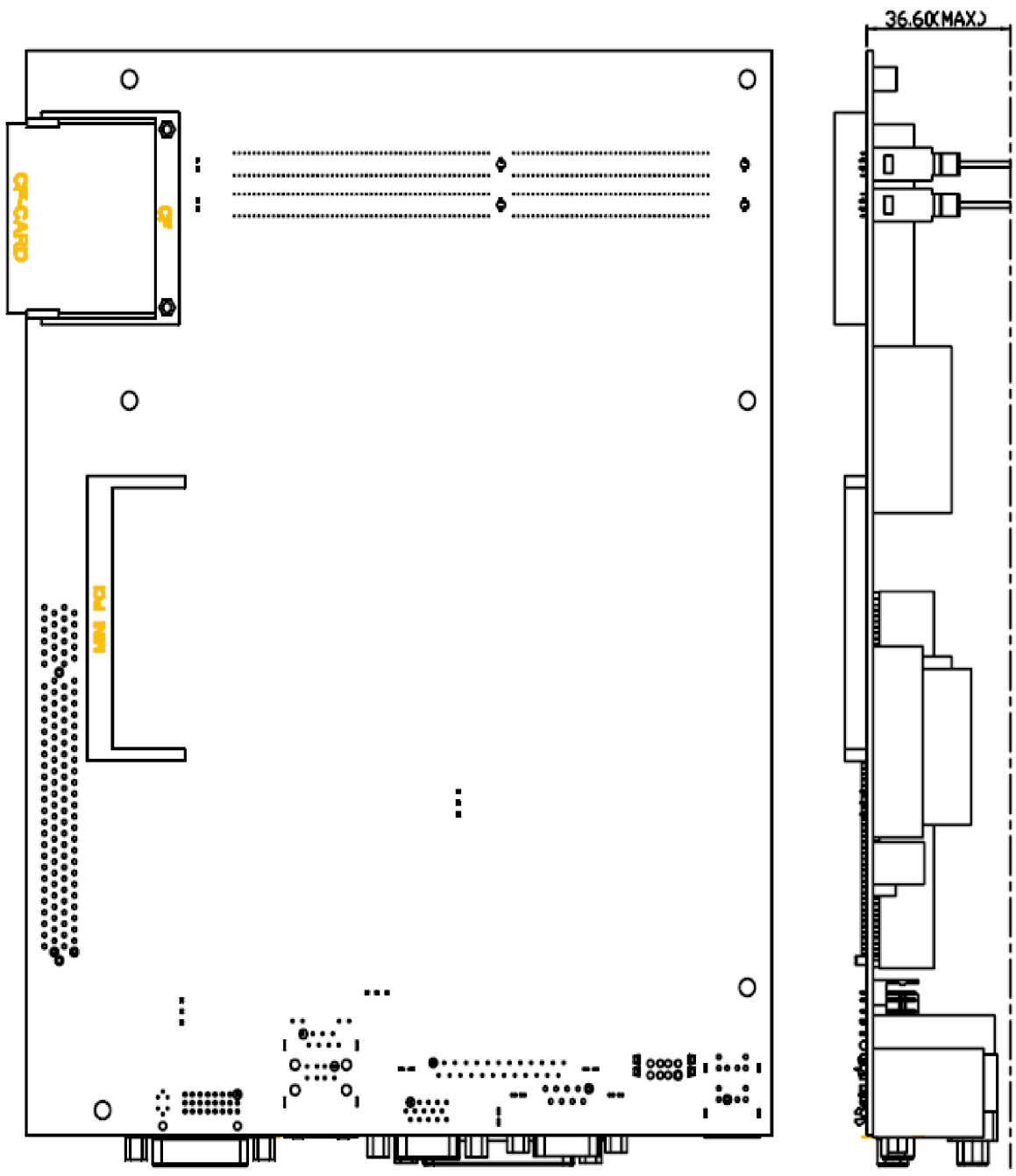

2.2 CPU INSTALLATION

The 3301860 embedded board supports a Socket 478 processor socket for Intel® Pentium® M or Celeron® M processors.

The processor socket comes with a screw to secure the processor. As shown in the left picture below, loosen the screw first before inserting the processor. Place the processor into the socket by making sure the notch on the corner of the CPU corresponds with the notch on the inside of the socket. Once the processor has slide into the socket, fasten the screw. Refer to the figures below.

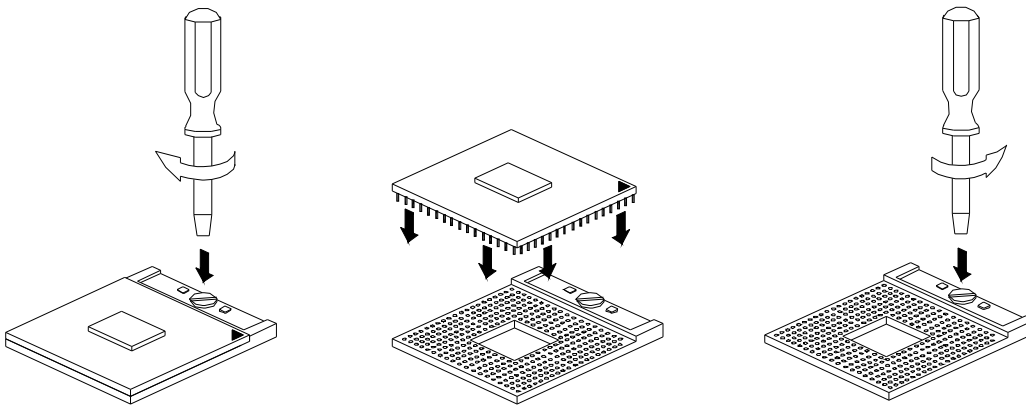

After you have installed the processor into the socket, check if the jumpers for the CPU type and speed are correct.

2.3 MEMORY INSTALLATION

The 3301860 embedded board supports two DDR memory sockets for a maximum total memory of 2GB in DDR memory type. The memory module capacities supported are 64MB, 128MB, 256MB, 512MB and 1GB. The following table lists the supported DDR DIMM configurations. Intel 855GME supports configurations defined in the JEDEC DDR DIMM specification only (A,B,C). Non-JEDEC standard DIMMs such as double-sided x16 DDR SDRAM DIMMs are not supported.

Density	64M bit		128Mbit		256Mbit		512Mbit	
Device Width	X8	X16	X8	X16	X8	X16	X8	X16
Single/Double	SS/DS	SS/DS	SS/DS	SS/DS	SS/DS	SS/DS	SS/DS	SS/DS
184-pin DDR	64M / 128M	32M / NA	128M/ 256M	64M / NA	256M/ 512M	128M/ NA	256M/ 1024M	256M/ NA

Supported DDRM DIMM Configurations

To install the DDR modules, locate the memory slot on the embedded board and perform the following steps:

1. Hold the DDR module so that the key of the DDR module align with those on the memory slot.
2. Gently push the DDR module in an upright position until the clips of the slot close to hold the DDR module in place when the DDR module touches the bottom of the slot.
3. To remove the DDR module, press the clips with both hands.

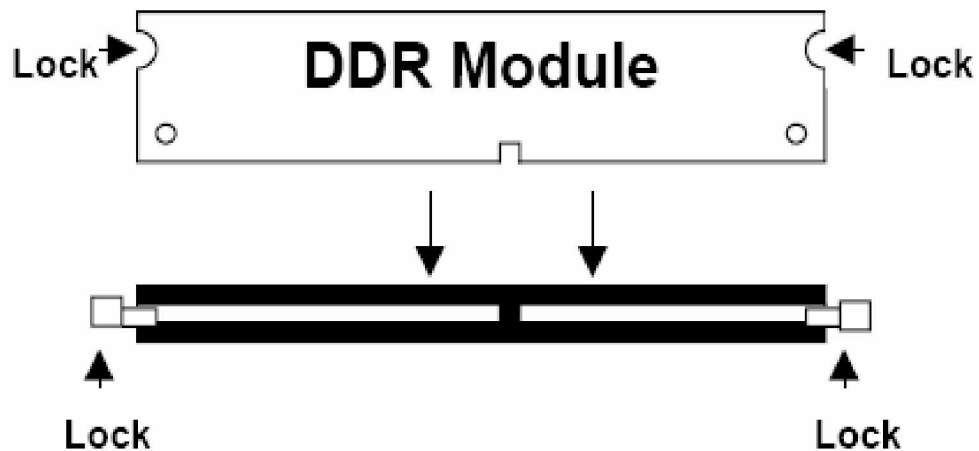

3. CONNECTION

The connectors on 3301860 allows you to connect external devices such as USB devices, serial port drives, hard disk devices, printers, etc. The following table lists the connectors on 3301860 and their respective functions.

3.1 PS2 KEYBOARD & MOUSE KBMS1

To install a PS/2 port keyboard and mouse, plug the mouse to the upper port green and the keyboard to the lower port purple.

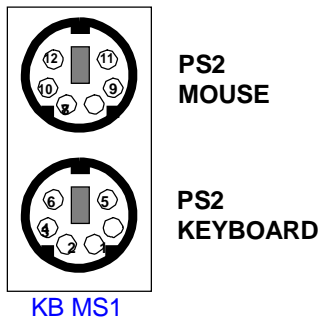

PIN	SIGNAL	PIN	SIGNAL
1	KBDAT	7	MSDAT
2	N.C.	8	N.C.
3	GND	9	GND
4	+5V	10	+5V
5	KBCLK	11	MSCLK
6	N.C.	12	N.C.

3.2 USB CONNECTOR USB1

Before you connect your device into USB connectors, please make sure your devices such as USB keyboard, mouse, scanner, zip, speaker ...etc. have a standard USB interface, Also make sure your OS supports USB controller. If your OS doesn't support USB controller, please contact OS vendor for possible patch or driver upgrade. For more information please contact your OS or devices vendors.

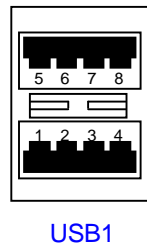

PIN	SIGNAL	PIN	SIGNAL
1	+5V	5	+5V
2	USB2-	6	USB3-
3	USB2+	7	USB3+
4	GND	8	GND

3.3 EXTERNAL USB HEADER USB3

The following table shows the pin outs of the USB pin headers connectors. Overall, the two pin headers support four USB ports USB 2.54 compliant.

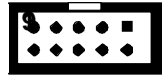

10 2
USB3

PIN	SIGNAL	PIN	SIGNAL
1	+5V	2	+5V
3	USB4-	4	USB5-
5	USB4+	6	USB5+
7	GND	8	GND

3.4 PARALLEL PORT CONNECTOR LPT1

The parallel port allows connection of a printer, scanner and other peripheral devices.

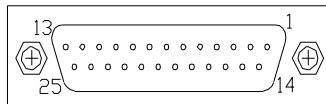

LPT1

PIN	SIGNAL	PIN	SIGNAL
1	STB#	14	AFD#
2	PD0	15	ERROR#
3	PD1	16	INIT#
4	PD2	17	SLIN#
5	PD3	18	GND
6	PD4	19	GND
7	PD5	20	GND
8	PD6	21	GND
9	PD7	22	GND
10	ACK#	23	GND
11	BUSY#	24	GND
12	PE	25	GND
13	SLCT		

3.5 SERIAL PORT CONNECTOR COM1

Devices like mouse, modems ...etc, can be connected to serial port.

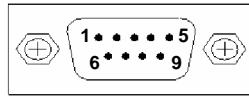

COM1

PIN	SIGNAL	PIN	SIGNAL
1	DCDA	6	DSRA
2	RXDA	7	RTSA
3	TXDA	8	CTSA
4	DTRA	9	RIA
5	GND		

3.6 EXTERNAL SERIAL PORT HEADER COM2~COM6

The following table describes the pin out assignments of this connector.

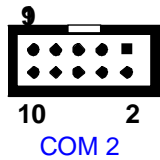

COM 2

PIN	SIGNAL	PIN	SIGNAL
1	DCDB	6	DSRB
2	RXDB	7	RTSB
3	TXDB	8	CTSB
4	DTRB	9	RIB
5	GND	10	GND

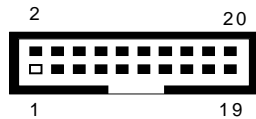

COM3, COM4

PIN	SIGNAL	PIN	SIGNAL
1	DCDC	2	DSRC
3	RXDC	4	RTSC
5	TXDC	6	CTSC
7	DTRC	8	RIC
9	GND	10	N.C.
11	DCDD	12	DSRD
13	RXDD	14	RTSD
15	TXDD	16	CTSD
17	DTRD	18	RID
19	GND	10	N.C.

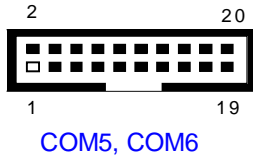

PIN	SIGNAL	PIN	SIGNAL
1	DCDE	2	DSRE
3	RXDE	4	RTSE
5	TXDE	6	CTSE
7	DTRE	8	RIE
9	GND	10	N.C.
11	DCDF	12	DSRF
13	RXDF	14	RTSF
15	TXDF	16	CTSF
17	DTRF	18	RIF
19	GND	20	N.C.

3.6 VGA CONNECTOR VGA1

Monitor can be connected to VGA port.

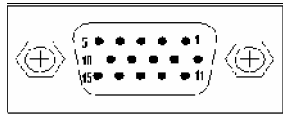

VGA1

PIN	SIGNAL	PIN	SIGNAL
1	RED	9	+5V
2	GREEN	10	GND
3	BLUE	11	N.C.
4	N.C.	12	SDA
5	GND	13	HSYNC
6	GND	14	VSYNC
7	GND	15	SCL
8	GND		

3.7 RJ-45 & USB CONNECTOR CN2

The provided Internet connection is fast Ethernet, providing data transfer speeds of 10/100Mbps. Plug the Ethernet to the upper port and USB devices to the lower port.

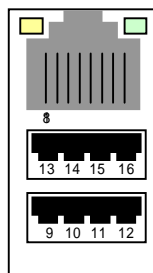

CN2

PIN	SIGNAL	PIN	SIGNAL
1	TX+	9	+5V
2	TX-	10	USB0-
3	RX+	11	USB0+
4	N.C.	12	GND
5	N.C.	13	+5V
6	RX-	14	USB1-
7	N.C.	15	USB1+
8	N.C.	16	GND

3.8 DVI-D CONNECTOR CN1

Monitor can be connected to DVI-D port.

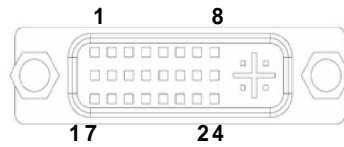

CN1

PIN	SIGNAL	PIN	SIGNAL
1	TMDS_TX2N	2	TMDS_TX2P
3	GND	4	N.C.
5	N.C.	6	TMDS_CLK
7	TMDS_DATA	8	VSYNC
9	TMDS_TX1N	10	TMDS_TX1P
11	GND	12	N.C.
13	N.C.	14	+5V
15	GND	16	TMDS_HPD
17	TMDS_TX0N	18	TMDS_TX0P
19	GND	20	N.C.
21	N.C.	22	GND
23	TMDS_TXCP	24	TMDS_TXCN

3.9 AUDIO LINE OUT/LINE INMIC HEADER J4

Include Line out, Line in, and MIC. Devices like CD-ROM, walkman etc. can be connected to line in. Connect the speaker, earphone to line out. Microphone can be connected to MIC.

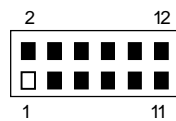

J4

PIN	SIGNAL	PIN	SIGNAL
1	R_OUT	2	L_OUT
3	GND	4	GND
5	R_IN	6	L_IN
7	GND	8	GND
9	N.C.	10	MIC_IN
11	GND	12	+12V

3.10 CD IN HEADER J6

Connect CD-ROM or DVD-ROM audio out to the connector.

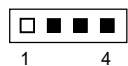

J6

PIN	SIGNAL	PIN	SIGNAL
1	CD_L	3	GND
2	GND	4	CD_R

3.12 HARD DISK IDE CONNECTOR (IDE1, IDE2)

An IDE device connects to the computer via an IDE connector. One IDE connector can connect to one IDE cable, and the single IDE cable can then connect to two IDE devices (hard drive or optical drive). If you wish to connect two IDE devices, please set the jumper on one IDE device as Master and the other as Slave.

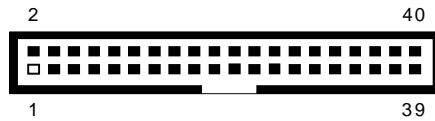

IDE1 Primary IDE Channel

PIN	SIGNAL	PIN	SIGNAL
1	IDERST	2	GND
3	PDATA7	4	PDATA8
5	PDATA6	6	PDATA9
7	PDATA5	8	PDATA10
9	PDATA4	10	PDATA11
11	PDATA3	12	PDATA12
13	PDATA2	14	PDATA13
15	PDATA1	16	PDATA14
17	PDATA0	18	PDATA15
19	GND	20	N.C.
21	PDDREQ	22	GND
23	PDDIOW	24	GND
25	PDDIOR	26	GND
27	PIORDY	28	GND
29	PDDACK	30	GND
31	IRQ14	32	N.C.
33	PDA1	34	P66DET
35	PDA0	36	PDA2
37	PDCS1	38	PDCS3
39	HDDLED	40	GND

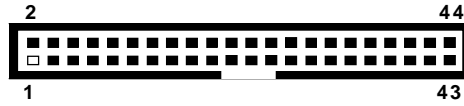

IDE2 Secondary IDE Channel

PIN	SIGNAL	PIN	SIGNAL
1	IDERST	2	GND
3	SDATA7	4	SDATA8
5	SDATA6	6	SDATA9
7	SDATA5	8	SDATA10
9	SDATA4	10	SDATA11
11	SDATA3	12	SDATA12
13	SDATA2	14	SDATA13
15	SDATA1	16	SDATA14
17	SDATA0	18	SDATA15
19	GND	20	N.C.
21	SDDREQ	22	GND
23	SDDIOW	24	GND
25	SDDIOR	26	GND
27	SIORDY	28	GND
29	SDDACK	30	GND
31	IRQ15	32	N.C.
33	SDA1	34	S66DET
35	SDA0	36	SDA2
37	SDCS1	38	SDCS3
39	HDDLED	40	GND
41	+5V	42	+5V
43	GND	44	N.C.

3.13 COMPACT FLASH CONNECTOR CFB1

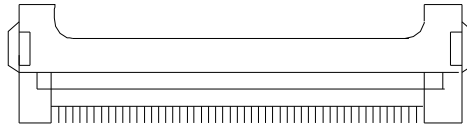

CFB1 Secondary IDE Channel

PIN	SIGNAL	PIN	SIGNAL
1	GND	2	SDATA3
3	SDATA4	4	SDATA5
5	SDATA6	6	SDATA7
7	SDCS1	8	GND
9	GND	10	GND
11	GND	12	GND
13	+5V	14	GND
15	GND	16	GND
17	GND	18	SDA2
19	SDA1	20	SDA0
21	SDATA0	22	SDATA1
23	SDATA2	24	GND
25	GND	26	GND
27	SDATA11	28	SDATA12
29	SDATA13	30	SDATA14
31	SDATA15	32	SDCS3
33	GND	34	SDDIOR
35	SDDIOW	36	+5V
37	IRQ15	38	+5V
39	M/S SELECT	40	N.C.
41	IDERST	42	SIORDY
43	N.C.	44	+5V
45	HDDLED	46	N.C.
47	SDATA8	48	SDATA9
49	SDATA10	50	GND

Compact Flash (CFB1) and IDE 2 share the same channel. Since a Compact Flash card is installed in the socket, the IDE 2 device will become unusable. CF card & IDE2 device cannot use at the same time.

3.14 COMPACT FLASH CONNECTOR MASTER/SLAVE SELECT HEADER (JP3)

Set the jumper on one compact flash device as Master and the other as Slave.

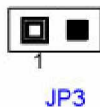

PIN	SIGNAL
1-2 ON	MASTER MODE
1-2 OFF	SLAVE MODE (Factory Preset)

3.15 CPU CLOCK SELECT HEADER (JCLK1)

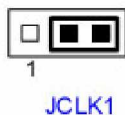

PIN	SIGNAL
1-2 ON	133 MHZ
2-3 ON	100 MHZ (Factory Preset)

3.16 INTERNAL BUZZER (BZ1)



PIN	SIGNAL
1	+5V
2	SPEAK

3.17 CPU FAN POWER CONNECTOR (FAN1, FAN2, FAN3)

FAN1, FAN2, FAN3 is a three pin header for system fans. These fans power supplies +12V power voltage.

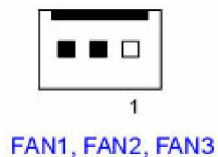

PIN	SIGNAL
1	GND
2	+12V
3	SENSE

3.18 COMS BATTERY HEADER JBAT1

You may clear the COMS data to its default values by this jumper. To clear COMS, temporarily short pins 1-2. To prevent improper use of this header, we do not include a jumper on it.



JBAT1

PIN	SIGNAL
1-2 ON	NORMAL OPERATION (<i>Factory Preset</i>)
2-3 ON	CLEAR CMOS

3.19 18, 24 BITS LVDS CONNECTOR LCD1, LCD4

The LVDS connector is composed of this channel to support 18-bit. This device is an alternative.

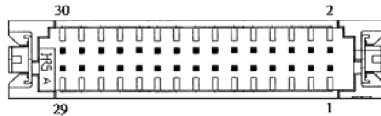

LCD4

PIN	SIGNAL	PIN	SIGNAL
1	VCC_LVDS	2	GND
3	RXEC-	4	RXEC+
5	GND	6	RXE2-
7	RXE2+	8	GND
9	RXE1-	10	RXE1+
11	RXE3+	12	RXE3-
13	RXE0+	14	RXE0-
15	GND	16	RXOC+
17	RXOC-	18	GND
19	RXO2+	20	RXO2-
21	DDCLK	22	RXO1+
23	RXO1-	24	DDDATA
25	RXO0+	26	RXO0-
27	RXO3+	28	RXO3-
29	VCC_LVDS	30	VCC_LVDS

The device for ATI chipset. Default

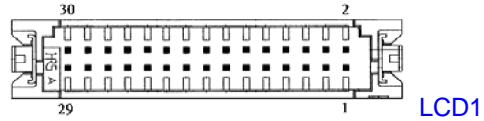

PIN	SIGNAL	PIN	SIGNAL
1	VCC_LVDS	2	GND
3	RXEC-	4	RXEC+
5	GND	6	RXE2-
7	RXE2+	8	GND
9	RXE1-	10	RXE1+
11	RXE3+	12	RXE3-
13	RXE0+	14	RXE0-
15	GND	16	RXOC+
17	RXOC-	18	GND
19	RXO2+	20	RXO2-
21	DDCLK	22	RXO1+
23	RXO1-	24	DDDATA
25	RXO0+	26	RXO0-
27	RXO3+	28	RXO3-
29	VCC_LVDS	30	VCC_LVDS

The device for Intel 855GME chipset, and only support LVDS 18 Bits.(Option)

3.20 LVDS INTERVER CONNECTOR J7, JJ1

This device is an alternative.

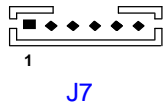

PIN	SIGNAL	PIN	SIGNAL
1	+12V	4	BKLTEN
2	+12V	5	GND
3	GND	6	BKLTCL

The device for Intel 855GME chipset.

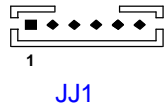

PIN	SIGNAL	PIN	SIGNAL
1	+12V	4	BLON
2	+12V	5	GND
3	GND	6	N.C.

The device for ATI chipset. BLON for ON/OFF control ON=+3.3V OFF=0V.

3.21 LCD PANEL TYPE SELECT (S1)

The switch can to select the LCD panel type.

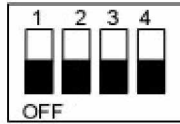

S1

PIN1	PIN2	PIN3	PIN4	SIGNAL
ON	ON	OFF	N.C.	800X600 18Bit
ON	OFF	OFF	N.C.	1024X768 18Bit
OFF	ON	OFF	N.C.	1024X768 24Bit
OFF	OFF	ON	N.C.	1280X1024 18Bit 2ch
N.C.	N.C.	N.C.	OFF	ATI M9 CRT

3.22 DDR SDRAM SOCKET (DIMM1, DIMM2)

The board has 2 dual inline memory module (DIMM) sockets.

3.23 MINI PCI SLOT (MPCIB1)

The board has one mini PCI slot.

3.24 PCI SLOT (PCI1)

The board has one PCI slot.

3.25 PCI SELECT HEADER (JP2)

You can be set the jumper on one PCI slot as Riser card and the other as PCI device.



1

JP2

PIN	SIGNAL
1-2 ON	ONE PCI CARD (<i>Factory Preset</i>)
2-3 ON	RISER CARD

3.26 ATX/ATX_12V POWER CONNECTOR ATX1, PW1

With the use of the power connector, the power supply can enough stable power to all the components on the board. Before connecting the power connector, please make sure that all components and devices are properly installed. Align the power connector with its proper location on the board and connect tightly. The ATX_12V PW1 power connector mainly supplies power to the CPU. If the ATX_12V PW1 power connector is not connected, the system will not start.

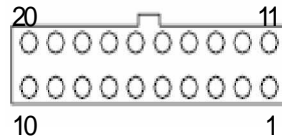

ATX1

PIN	SIGNAL	PIN	SIGNAL
1	+3.3V	11	+3.3V
2	+3.3V	12	-12V
3	GND	13	GND
4	+5V	14	PSON
5	GND	15	GND
6	+5V	16	GND
7	GND	17	GND
8	PWOK	18	-5V
9	+5VSB	19	+5V
10	+12V	20	+5V

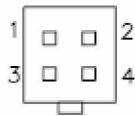

PW1

PIN	SIGNAL
1	GND
2	GND
3	+12V
4	+12V

3.27 PANEL HEADER J1

Please connect the power LED, IDE Hard disk active LED, reset switch and power switch etc.

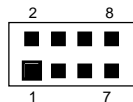

J1

PIN	SIGNAL
1-3	POWER BUTTON
5-7	RESET BUTTON
2-4	POWER LED
6-8	HDD LED

4. WATCHDOG TIMER CONFIGURATION

The WDT Watch Dog Timer is used to generate a variety of output signals after a user programmable count. The WDT is suitable for use in the prevention of system lock-up, such as when software becomes trapped in a deadlock. Under these sort of circumstances, the timer will count to zero and the selected outputs will be driven. Under normal circumstance, the user will restart the WDT at regular intervals before the timer counts to zero.

4.1 WATCHDOG TIMER SETTING

The watchdog timer is a circuit that maybe be used from your program software to detect crash or hang up. The Watchdog timer is automatically disabled after reset. Once you enabled the watchdog timer, your program should trigger the watchdog timer every time before it times out. After you trigger the watchdog timer, the timer will be set to zero and start to count again. If your program fails to trigger the watchdog timer before times out, it will generate a reset pulse to reset the system or trigger the IRQ 9 signal in order to tell your system that the watchdog time is out.

Users could test watchdog function under 'Debug' program as follows:

```
C:>debug
o 2e 87 ;Extended Functions Enable Register
o 2e 87 ;Extended Functions Enable Register
o 2e 07 ;EFIR=EFER (Extended Functions Index Register)
point to Logical Device Number Reg.
o 2f 08 ;EFDR=EFIR+1,select logical device 8
o 2e 30 ;select CR30
o 2f 01 ;update CR30 with value 01H
o 2e f6 ;select CRF6
o 2f 08 ;update CRF6 with value 08H ,(8sec reset)
q
```

5. BIOS CONSOLE

This chapter describes the 3301860 BIOS menu displays and explains how to perform common tasks needed to get up and running, and presents detailed explanations of the elements found in each of the BIOS menus. The following topics are covered:

- z Main Setup
- z Advanced Chipset Setup
- z Power Setup
- z Peripherals Setup
- z PnP/PCI Setup z
- PC Health Setup
- z Boot Setup
- z Exit Setup

5.1 MAIN SETUP

The <Main Setup> choice allows you to record some basic hardware configuration in your computer system and set the system clock and error handling. If the motherboard is already installed in a working system, you will not need to select this option. You will need to run this Setup option, however, if you change your system hardware configuration, the onboard battery fails, or the configuration stored in the COMS memory was lost or damaged.

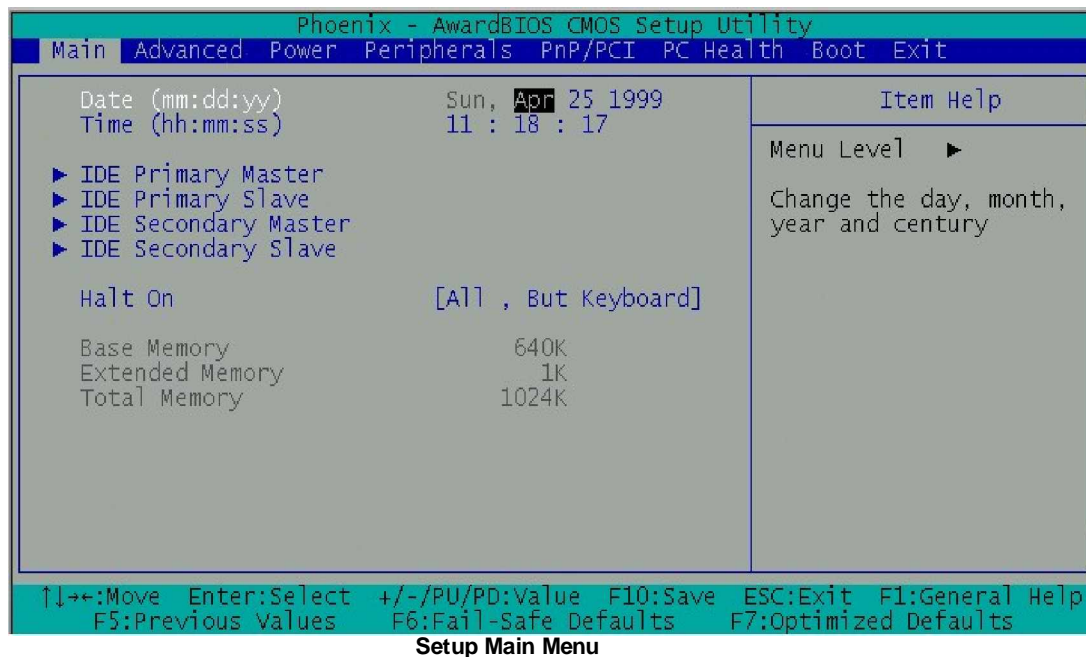

About the button of the menu are the control keys for use on this menu. If you need any help in each item field, you can press the F1 key, It will display the relevant information to help you. The memory display at the automatically according to the memory changed. The following describes each item of this menu.

Date Setup

The date format is
DAY SUN to SAT
Month 1 to 12
Date 1 to 31
Year 1999 to 2099

To set the date, highlight the "Date" field and use the PageUp/PageDown to set the current date.

Time Setup

The time format is
Hour SUN to SAT
Minute 00 to 59
Second 00 to 59

To set the time, highlight the "Time" field and use the PageUp/PageDown to set the current time.

IDE Primary HDDs/IDE Secondary HDDs

The onboard PCI IDE connectors provide primary and secondary channels for connecting up to four IDE hard disks or other devices. Each channel can support up to two hard disks; the first is the "Master" and the second is "Slave".

Press Enter to configure the hard disk. The selections include Auto, Manual, and None. Select Manual to define the device information manually. You will be asked to enter the following items.

CYLS Number of cylinders.

HEAD Number of read/write heads.

PRECOMP Write precompensation.

LANDING SONE Landing zone.

SECTOR Number of sectors.

The Access Mode selections are as follows

CHS HD<528MB

LBA HD>528MB and support Logical Block Addressing

Large for MS-DOS only

Auto

Video

The field selects the type of video display card installed in your system. You can choose the following Video display cards

EGA/VGA For EGA, VGA, SEGA, SVGA or PGA monitor adapters.default

CGA 40 Power up in 40 column mode.

CGA 80 Power up in 80 column mode.

MONO For Hercules or MDA adapters.

Halt On

The field determines whether or not the system will halt if an error is detected during the power up.

No errors The system boot will not be halted for any error that may de detected.

All errors Whenever the BIOS detects a non-fatal error, the system will stop and you will be prompted. All,

But Keyboard The system boot will not be halted for a keyboard error; it will stop for all other errors.

5.2 ADVANCED CHIPSET SETUP

This section allows you to configure and improve your system and follows you to set up some system features according to your preference.

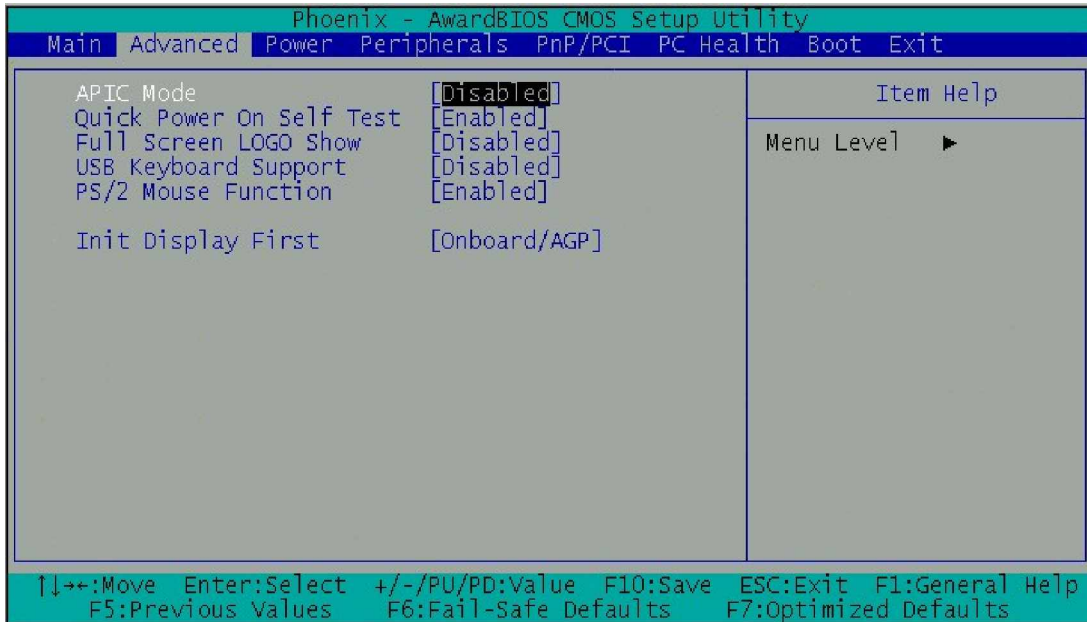

Advanced Chipset Setup

APIC Mode

APIC stands for Advanced Programmable Interrupt Controller. The default setting is **Disabled**.

Quick Power On Self Test

When enabled, this field speeds up the Power On Self Test POST after the system is turned on. If it is set to *Enable*, BIOS will skip some items.

USB Keyboard Support

The options for this field are *Enabled* and *Disabled*. By default, the field is set to *Disabled*.

PS/2 Mouse Function

The options for this field are *Enabled* and *Disabled*. By default, the field is set to *Disabled*.

Init Display First

The default setting is *Onboard/AGP*. This determines which VGA controller is initialized when the system boots.

5.3 POWER SETUP

Use this main to specify your setting for power management.

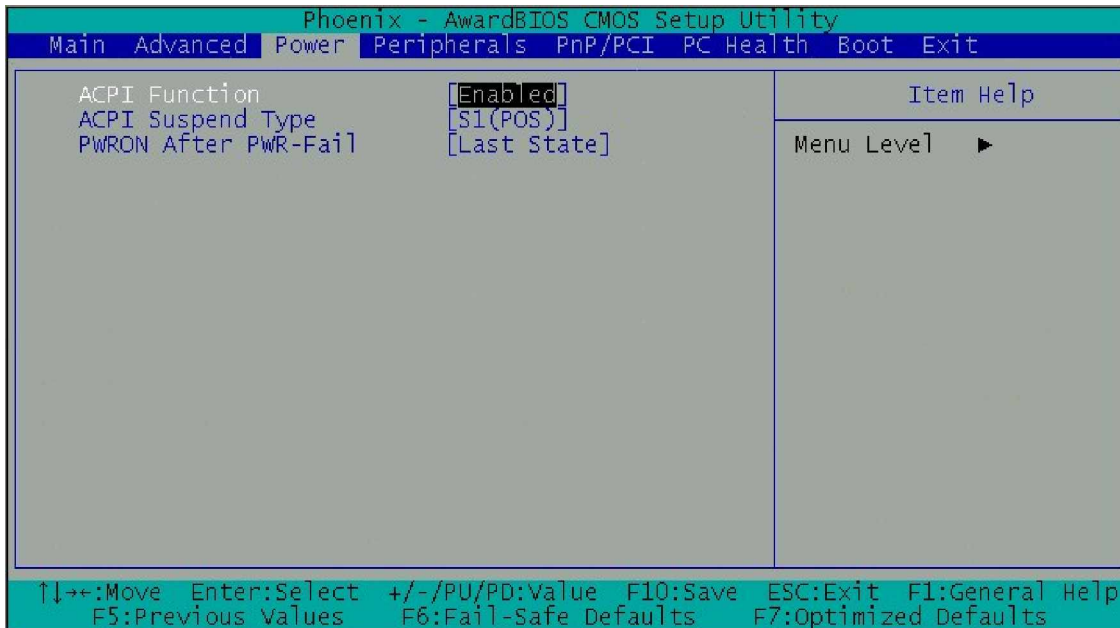

Power Setup

ACPI Function

Enable this function to support ACPI Advance Configuration and Power Interface.

ACPI Suspend Type

The options for this field are *S1 POS* and *S3 STR*. By default, the field is set to *S1 POS*.

PWRON After PWR-Fail

The field sets the system power status whether on or off when power returns from a power failure situation.

5.4 PERIPHERALS SETUP

This option controls the configuration of the board's chipset. Control keys for this screen are the same as for the previous screen.

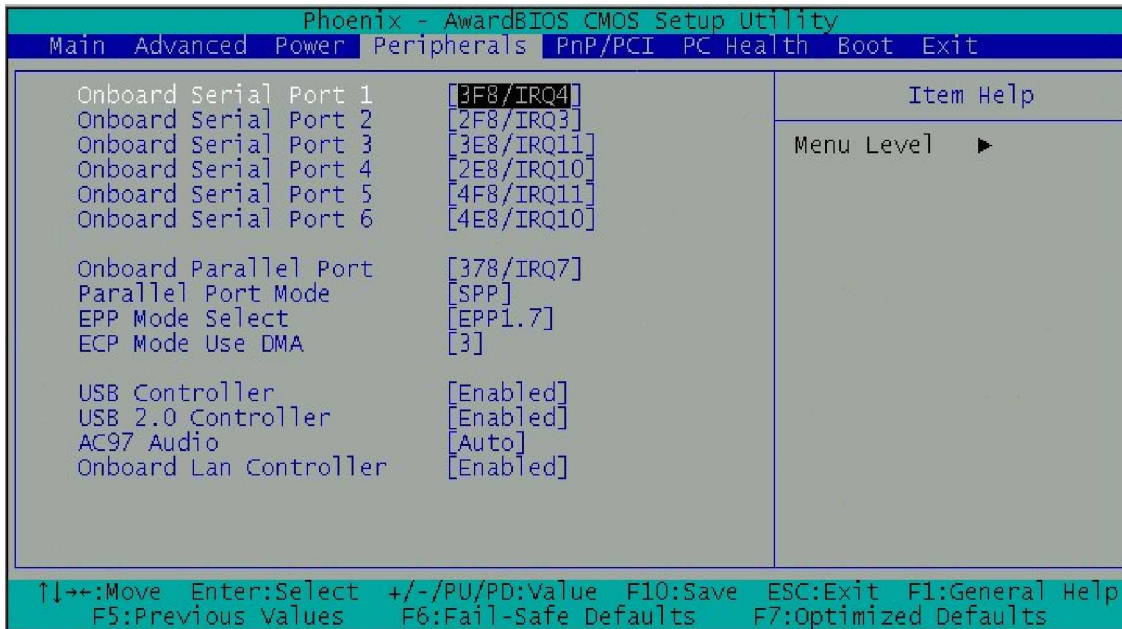

Peripherals Setup

Onboard Serial Port 1

Onboard Serial Port 2

Onboard Serial Port 3

Onboard Serial Port 4

Onboard Serial Port 5

Onboard Serial Port 6

These fields allow you to select the on board serial ports and their addresses. The default values for these ports are

Serial Port 1 3F8 / IRQ4

Serial Port 2 2F8 / IRQ3

Serial Port 3 3E8 / IRQ11

Serial Port 4 2E8 / IRQ10

Serial Port 5 4F8 / IRQ11

Serial Port 6 4E8 / IRQ10

Onboard Parallel Port

This field allow you to select the on board parallel port and their addresses. The default values for this port is

Parallel Port 378 / IRQ7

Parallel Port Mode

This field allow you determine parallel port mode function

SSP Standard Parallel Port

EPP Enhanced Parallel Port

ECP Extended Capabilities Port

USB Controller

The options for this field are *Enabled* and *Disabled*. By default, the field is set to *Enabled*.

USB 2.0 Controller

The options for this field are *Enabled* and *Disabled*. By default, the field is set to *Enabled*. In order to use USB 2.0, necessary OS drivers must be installed first. **Please update your system to Windows 2000 SP4 or Windows XP SP1.**

AC97 Audio

The default setting of the AC97 Audio is *Auto*.

Onboard Lan Controller

The default setting of the Lan controller is *Enabled*.

5.5 PNP/PCI SETUP

The option configures the PCI bus system. All PCI bus system on the system use INT#, thus all installed PCI cards must be set to this value.

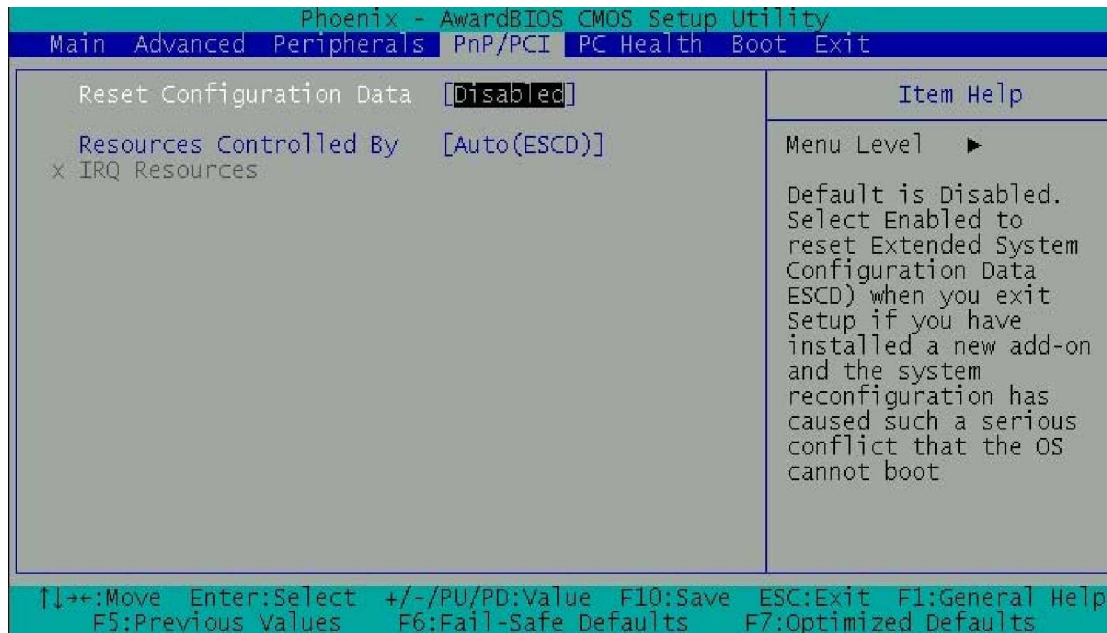

PnP / PCI Setup

Reset Configuration Data

This field allow you to determine whether to reset the configuration data or not. The default value is *Disabled*.

Resources Controlled By

This PnP BIOS can configure all of the boot and compatible devices automatically with the use of a use a PnP operating system such as Windows 95.

5.6 PC HEALTH SETUP

This section shows the parameters in determining the PC Health Status. These parameters include temperatures, fan speeds, voltages.

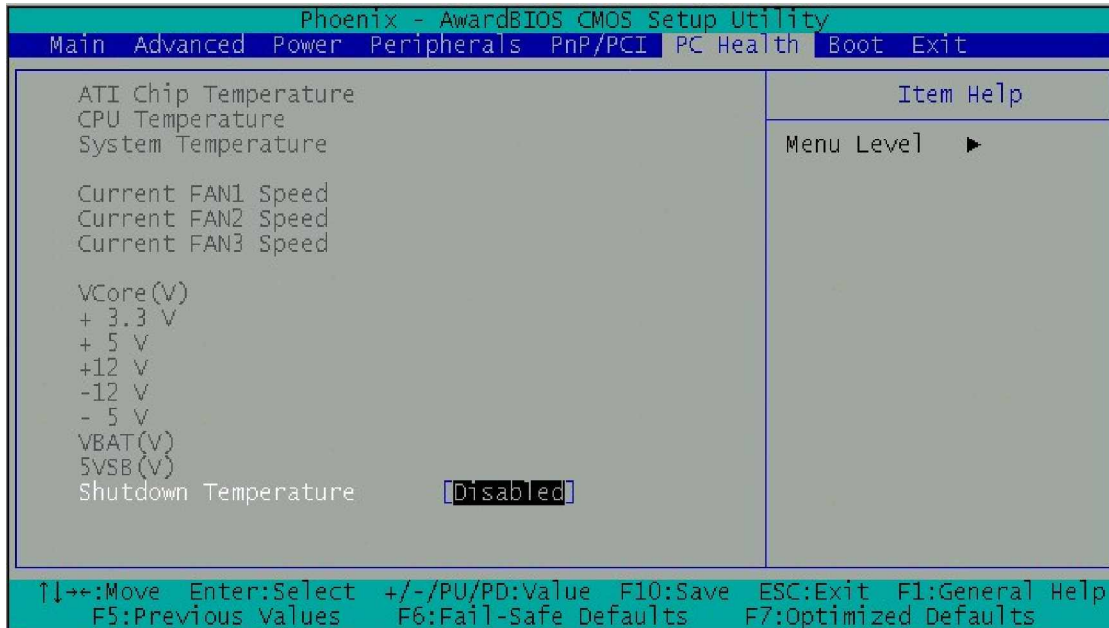

PC Health Status

Temperature / Voltage

These fields are parameters of the hardware monitoring function feature of the motherboard. The values are read-only values as monitored by the system and show the PC health status.

Shutdown Temperature

This field allows the user to set the temperature by which the system automatically shut down once the threshold temperature is reached. This function can help prevent damage to the system that is caused by overheating.

5.7 BOOT SETUP

This section is used to exit the BIOS main menu. After making your changes, you can either save them or exit the BIOS menu and without saving the new values



PCI / Plug And Play

First / Second / Third Boot Device

These fields determine the device that the system searches first for an operating system. The options available include Hard Disk, CDROM, USB-FDD, USB-CDROM and Disable.

Boot Other Device

These fields allow the system to search for an OS from other devices other than the ones selected in the First / Second / Third Boot Device.

5.8 EXIT SETUP

This section is used to configure exit mode.

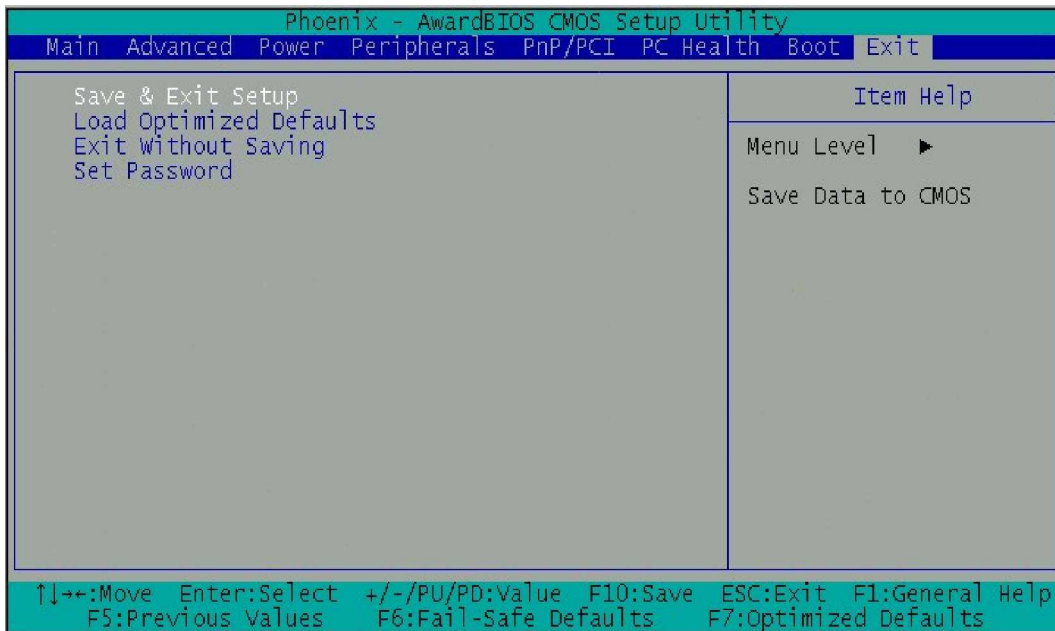

Exit Setup

Save & Exit Setup

This option allow you determine whether or not to accept the modifications. If you type “Y”, You will quit the setup utility and save all changes into the CMOS memory. If you type “N”, you will return to setup utility.

Load Optimized Defaults

This option allow you to load the default values to your system configuration. These default settings are optimal and enable all high performance features.

Exit Without Saving

Select this option to exit the Setup utility without saving the changes you have made in this session. Typing “Y” will quit the Setup utility without saving the modifications. Typing “N” will return to setup utility.

5.9 BIOS UPDATE

The BIOS program instructions are contained within computer chips called FLASH ROMs that are located on your system board. The chips can be electronically reprogrammed, allowing you to upgrade your BIOS firmware without removing and installing chips.

The 3301860 provides the FLASH BIOS update function for you to easily to update to a newer BIOS version. Please follow these operating steps to update to new BIOS

Step 1: Turn on your system and don't detect the CONFIG.SYS and AUTOEXEC.BAT files.

Step 2: You will get **AWDFLASH.EXE** and **XXXXXX.BIN** , please copy them to the boot disk .

Step 3: In the MS-DOS mode, you can type the AWDFLASH and press [ENTER] .

```
A:\> AWDFLASH
```

Step 4: A window will appear and ask you to type the complete BIOS file (**xxxxxx.BIN**) and press [ENTER] .

Step 5: Then it will ask whether you save the old BIOS file , you can choose the YES or NO .

Step 6: Then it will ask you whether want to program it , please choose YES .

Step 7: The BIOS will start to upgrade

Step 8: When you have successfully flashed the BIOS then press the[F1] to reboot the Computer and hit [DEL] to enter the BIOS CMOS SETTING . Select " LOAD S-STUP DEFAULTS " set as YES . Then save and exit the setting

Note

1. In order to prevent your system from hanging up during flashing BIOS , please check the new BIOS match your model name and current BIOS version .
2. In order to protect your motherboard , please don't turn off your computer during the flashing or it will damage your BIOS ROM .

APPENDIX A. ADDRESS MAPPING

IO ADDRESS MAP

Each peripheral device in the system is assigned a set of I/O port addresses which also becomes the identity of the device. The following table list the I/O addresses used.

I/O MAP	ASSIGNMENT
0000 - 000F	Direct Memory Access contrloer
0020 - 0021	Programmable interrupt controller
0040 - 0043	System timer
0060 - 0060	Standard 101/102 – key or Microsoft Natural Keyboard
0061 - 0061	System speaker
0070 - 0073	System CMOS/real time clock
00F0 - 00FF	Numeric data processor
0170 – 0177	Intel® 82801DB Ultra ATA Storage Controller-24CB
0170 – 0177	Secondary IDE Channel (dual fifo)
01F0 – 01F7	Intel® 82801DB Ultra ATA Storage Controller-24CB
01F0 – 01F7	Primary IDE Channel (dual fifo)
02F8 - 02FF	Communication Port (COM2)
0378 - 037F	Print Port
0382 - 03BB	ATI MOBILITY RADEON 9000
03F8 - 03FF	Communication Port (COM1)
C000 - CFFF	Intel ® 82852/82855GM/GME/PM/GMV Processor to AGP controller - 3581
D000 - D03F	Intel ® PRO/100 VE Network Connection
E800 - E81F	Intel® 82801DB/DBM USB Universal Host Controller
EB00 – EB3F	Realtek AC'97 Audio

MEMORY MAP

MEMORY MAP	ASSIGNMENT
00000000-0009FFFF	System board extension for ACPI BIOS
000A0000-000AFFFF	ATI MOBILITY RADEON 9000
000D0000-000D7FFF	Unavailable for use by devices
D8000000-DFFFFFFF	Intel ® 82852/82855GM/GME/PM/GMV to Processor I/O controller - 3580
E0000000-E7FFFFFF	Intel ® 82852/82855GM/GME/PM/GMV Processor to AGP controller - 3581
E8100000-E8100FFF	Intel ® PRO/100 VE Network Connection
E8100000-E81FFFFF	Intel® 82801DB PCI Bridge – 224E
E8200000-E82003FF	Intel USB 2.0 Enhanced Host Controller
E8201000-E82011FF	Realtek AC'97 Audio

APPENDIX B. INTERRUPT REQUEST (IRQ)

Peripheral devices use interrupt request lines to notify CPU for the services required. The following table shows the IRQ used by the devices on board.

Level	HARDWARE USING THE SETTING
00	System timer
01	Standard 101/102-Key or Microsoft Natural Keyboard
02	Programmable interrupt controller
03	Communication Port (COM2)
04	Communication Port (COM1)
05	ACPI IRQ Holder for PCI IRQ Steering
05	Realtek AC'97 Audio
05	Intel® 82801DB/DBM SM Bus Controller-24C3
07	Print Port (LPT1)
08	System CMOS/real time clock
09	ACPI IRQ Holder for PCI IRQ Steering
09	Intel USB2.0 Enhanced Host Controller
10	ATI MOBILITY RADEON 9000
11	Intel® PRO/100 VE Network Connection
12	PS/2 Compatible Mouse Port
13	Numeric data processor
14	Intel® 82801DB Ultra ATA Storage Controller-24CB
14	Primary IDE controller (dual fifo)
15	Secondary IDE controller (dual fifo)

Any advice or comments about our products and service, or anything we can help you with please don't hesitate to contact with us. We will do our best to support you for your products, projects and business

Global American Inc.

Address: 17 Hampshire Drive
Hudson, NH 03051

TEL: Toll Free (U.S. Only) 800-833-8999
(603)886-3900

FAX: (603)886-4545

Website: <http://www.globalamericaninc.com>

E-Mail: salesinfo@globalamericaninc.com

