



**User's Manual**

2002140

2002190

2002230

2002390

2004030

2004040

2004050

2004060

2007541

2007544

### **Copyrights**

This manual is copyrighted and all rights are reserved. It does not allow any non authorization in copied, photocopied, translated or reproduced to any electronic or machine readable form in whole or in part without prior written consent from the manufacturer.

In general, the manufacturer will not be liable for any direct, indirect, special, incidental or consequential damages arising from the use of inability to use the product or documentation, even if advised of the possibility of such damages. The manufacturer keeps the rights in the subject to change the contents of this manual without prior notices in order to improve the function design, performance, quality and reliability. The author assumes no responsibility for any errors or omissions, which may appear in this manual, nor does it make a commitment to update the information contained herein.

### **Trademarks**

Intel is a registered trademark of Intel Corporation.

Award is a registered trademark of Award Software, Inc.

All other trademarks, products and or product's name mentioned herein are mentioned for identification purposes only, and may be trademarks and/or registered trademarks of their respective companies or owners.

## General Information

The active matrix TFT (thin film transistor) liquid crystal display open frame module. It is designed to fit with custom housing for commercial use.

## Important Information

Warning: To reduce the risk of fire or electric shock, do not expose this product to rain or moisture.

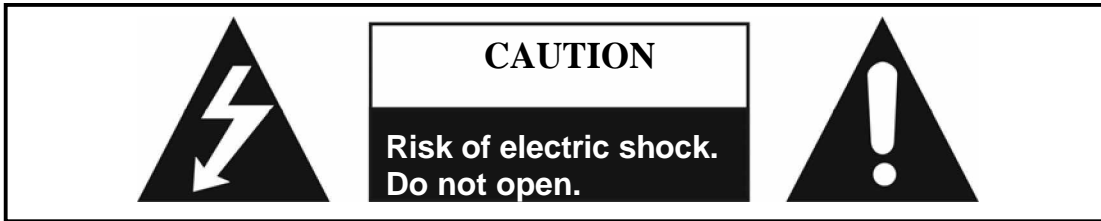

**Caution: To reduce the risk of electric shock, do not remove cover. No user-serviceable parts inside. Refer servicing to qualified service personnel.**

## Safety Precautions

1. **Cleaning:** Unplug the power cord from the AC outlet before cleaning the product. Use a damp cloth to clean the product. Do not use liquid cleaners or aerosol cleaners.
2. **Water and moisture:** Do not use the product near water, such as bathtub, washbasin, kitchen sink and laundry tub, swimming pool and in a wet basement.
3. **Heat sources:** Keep the product away from heat sources such as radiators, heaters, stoves and other heat-generating products (including amplifiers).
4. **Stand:** Do not place the product on an unstable Cart, stand, tripod or table. Placing the product on an unstable base can cause the product to fall, resulting in serious personal injuries as well as damage to the product.
5. If an extension cord is used with this product, make sure that the total of the ampere ratings on the products plugged into the extension cord does not exceed the extension cord ampere rating. Also make sure that the total of all products plugged into the wall outlet does not exceed 15 amps.



6. Ventilation-The vents and other openings are designed for ventilation. Do not cover or block these vents and openings since insufficient ventilation can cause overheating and/or shorten the life of the product.
7. The LCD panel used in this product is made of glass. Therefore, it can break when the product is dropped or struck. Be careful when cleaning up broken glass pieces if the LCD panel breaks.
8. The LCD panel is a very high technology product, giving you fine picture details. Occasionally, a few non-active pixels may appear on the screen as a fixed point of blue, green or red. This many non-active pixels are considered acceptable.
9. Do not attempt to service this product yourself, as opening or removing covers may expose you to dangerous voltage points or other risks and will void the warranty. Refer all servicing to qualified services personnel.

## Introduction

### About the Product

This product is a microprocessor-controlled to work with 6.4"- 42" TFT LCD Panel. It is designed to meet the demanding performance requirements of today's business and industrial applications.

### Notice

1. Do not touch the LCD panel Surface with sharp or hard objects.
2. Do not use abrasive cleaners, waxes or solvents for cleaning, use only a dry or damp, soft cloth.
3. Use only with a high quality, safety-approved, AC/DC power adapter.

### Check List

Before using this monitor, please make sure that all the items listed below are present in your package.

- |                                |    |
|--------------------------------|----|
| 1. VGA cable                   | x1 |
| 2. AC to DC Adapter (optional) | x1 |
| 3. Power Cable                 | x1 |
| 4. Serial Cable (optional)     | x1 |
| 5. USB Cable (optional)        | x1 |
| 6. DVI Cable (optional)        | x1 |
| 7. Audio Cable (optional)      | x1 |

If any items are missing or damaged, please contact your dealer immediately.

# Outline Drawing

## Type 1: Open Frame Monitor (6.4")

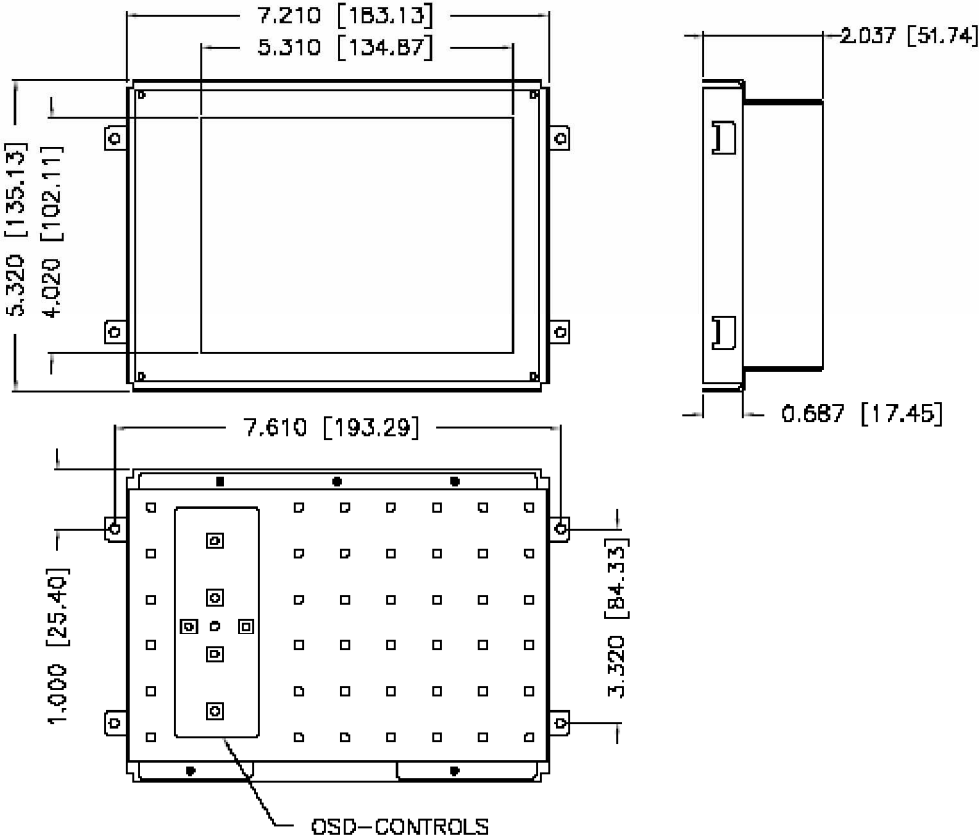

## Type 2: Open Frame Monitor (10")

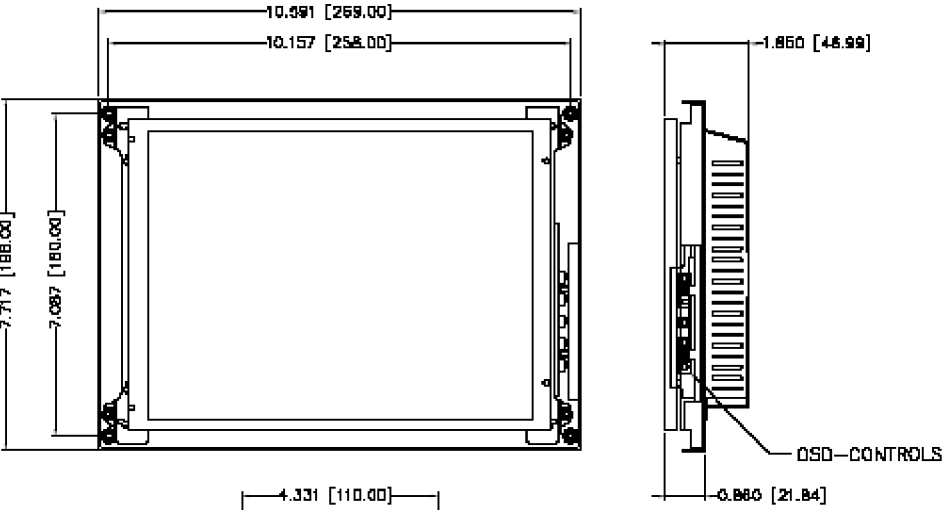

### Type 3: Open Frame Monitor (12")

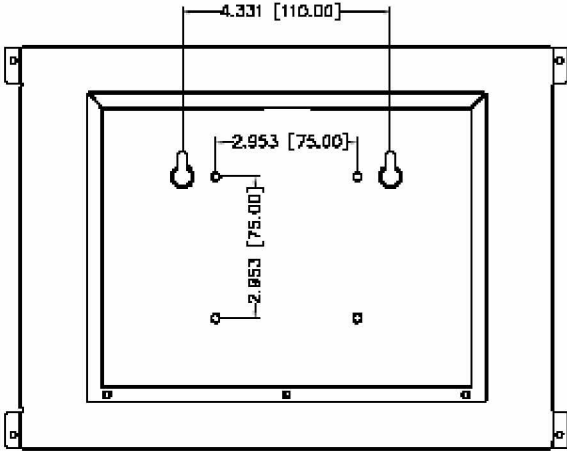
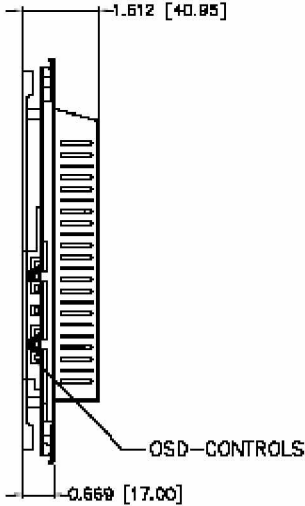
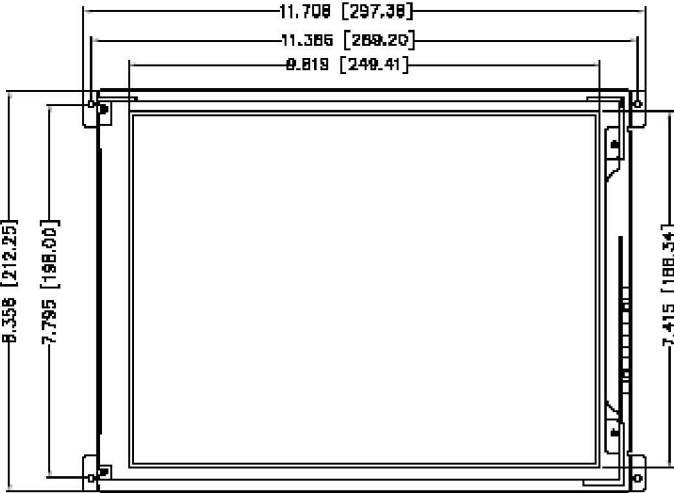

### Type 4: Open Frame Monitor (15")

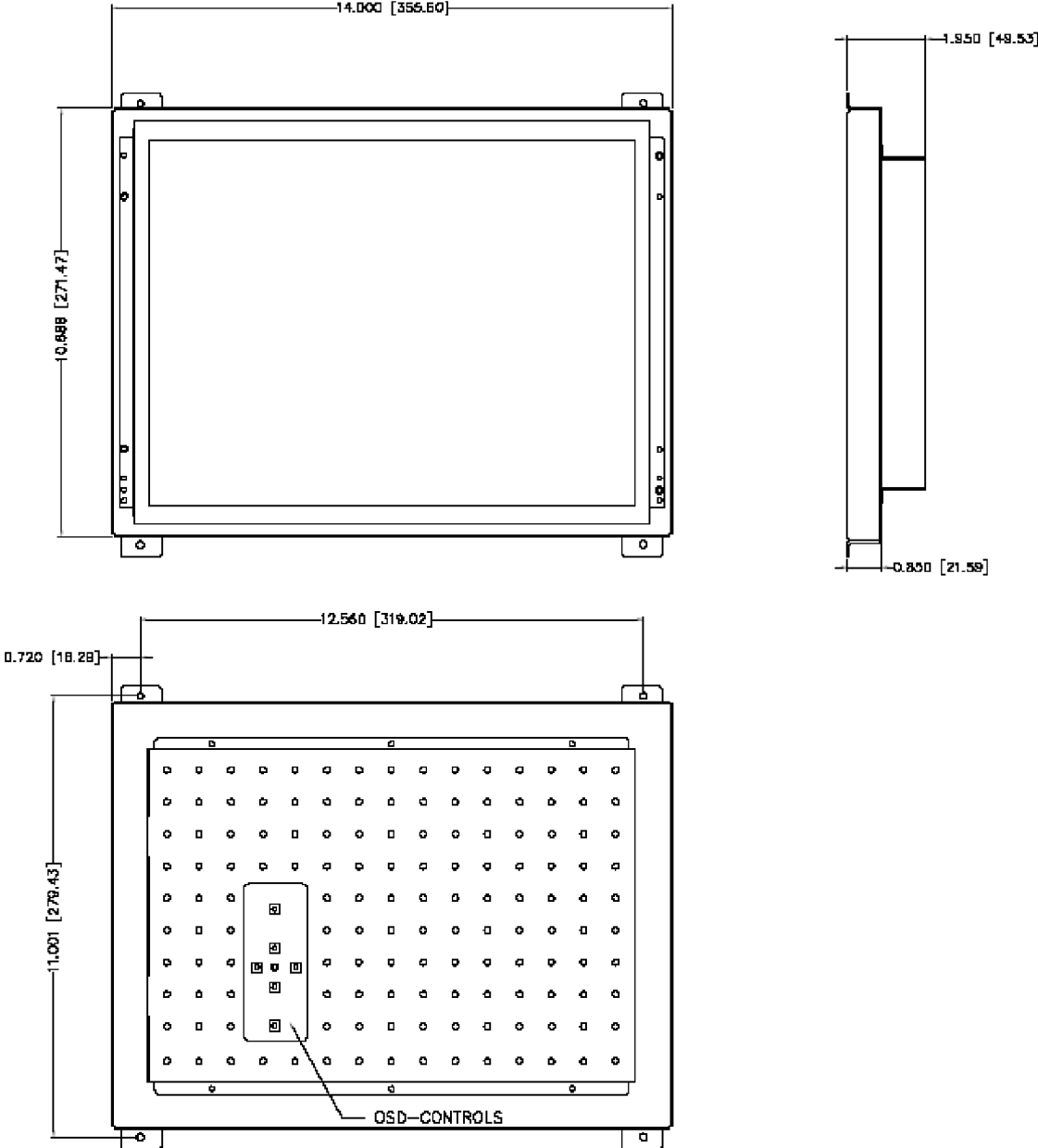

### Type 5: Open Frame Monitor (19")

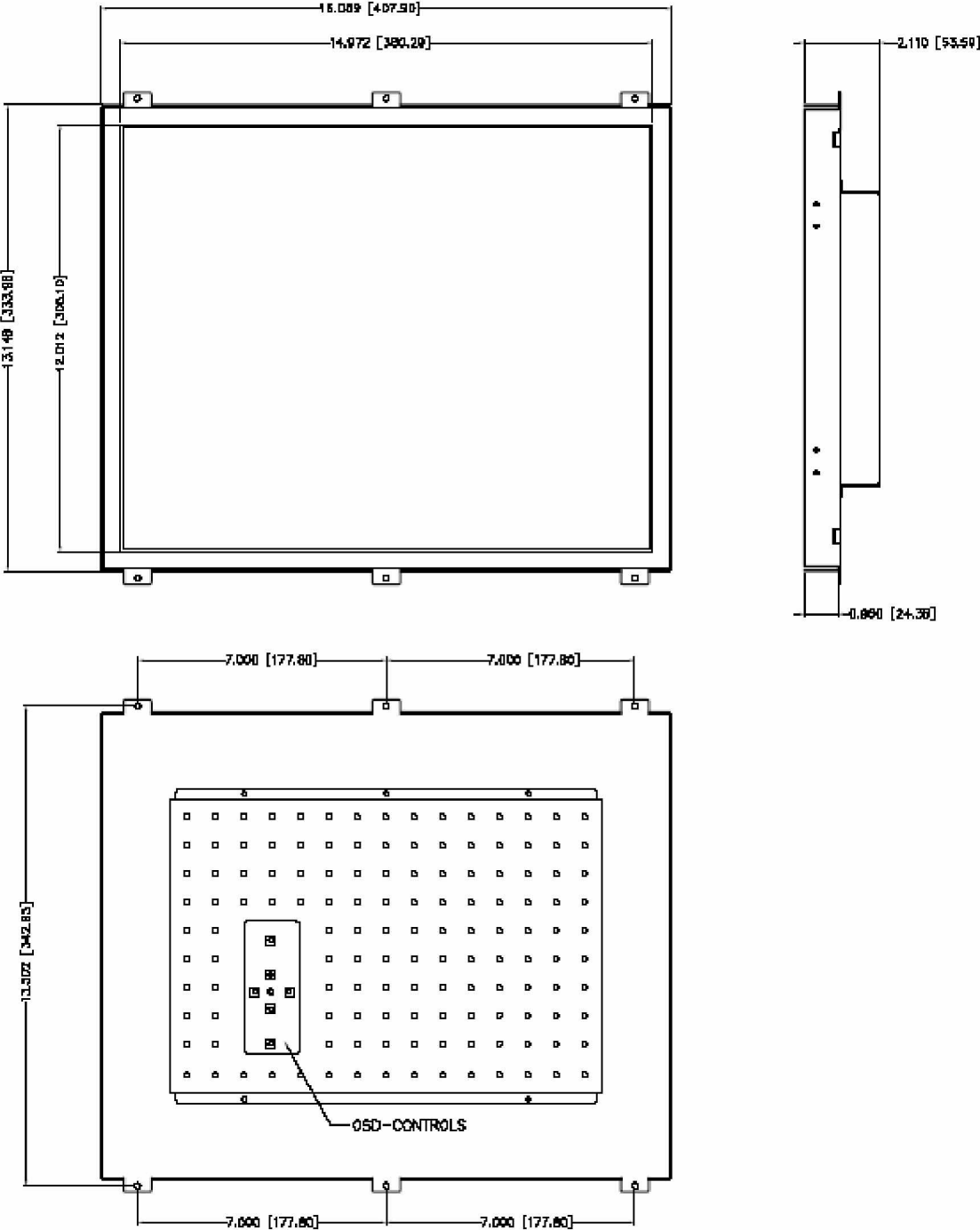

### Type 6: Open Frame Monitor (26")

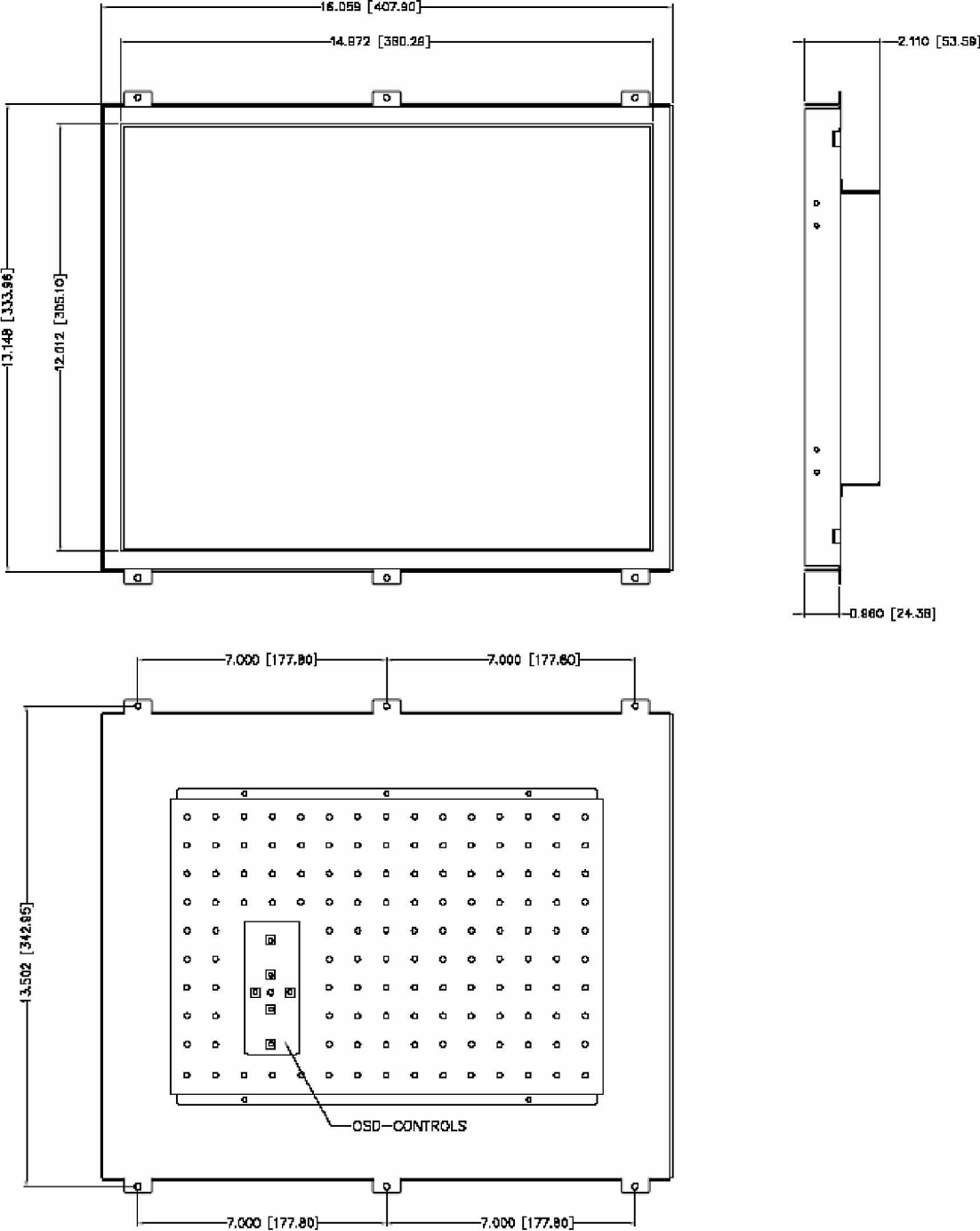

### Type 7: Open Frame Monitor (32")

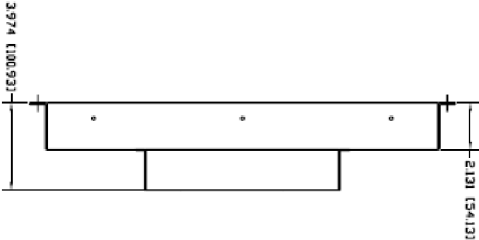
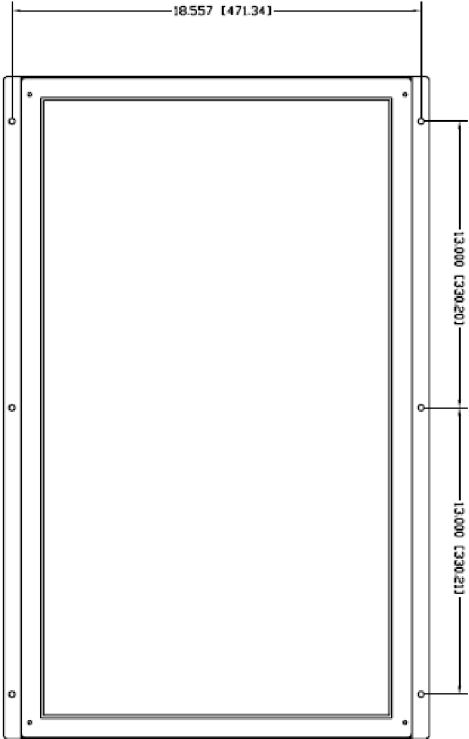
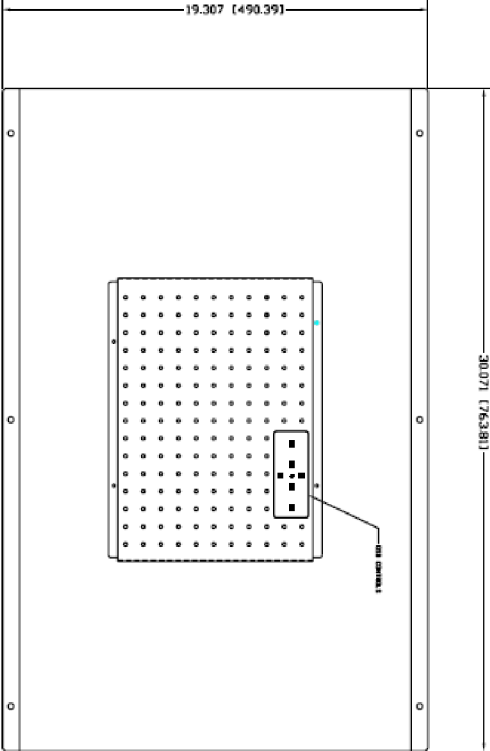

### Type 8: Open Frame Monitor (37")

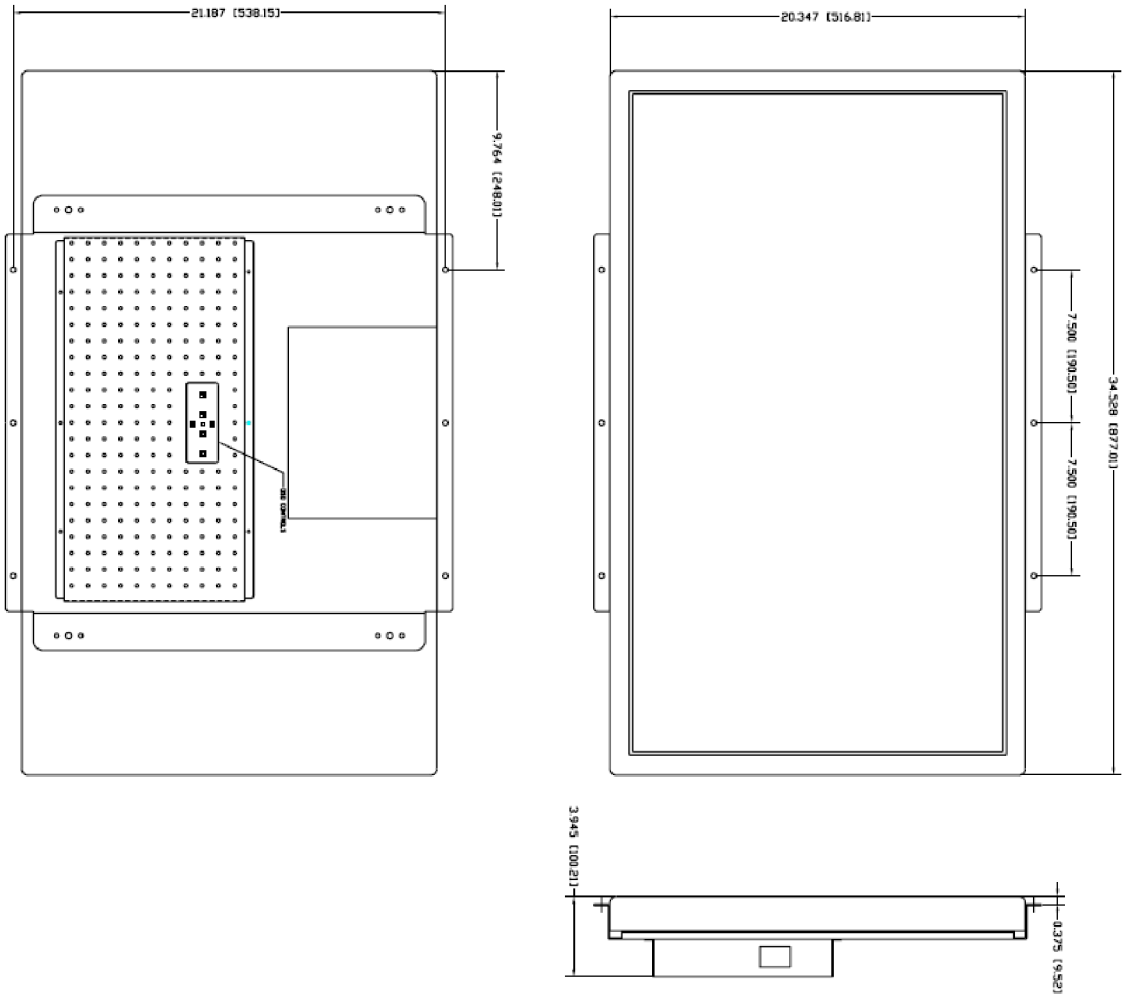

### Type 9: Open Frame Monitor (42")

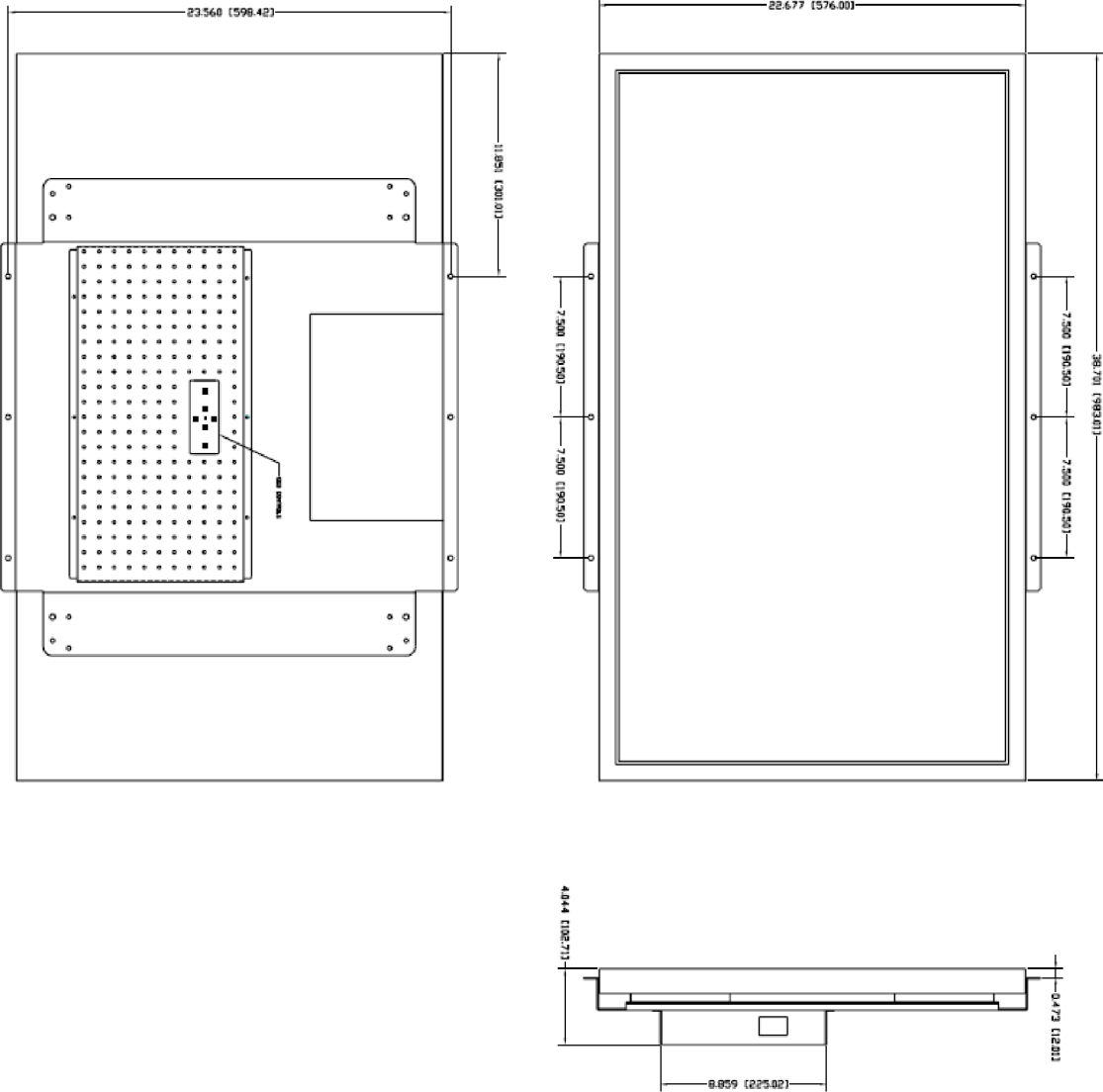

## OSD Board Layout

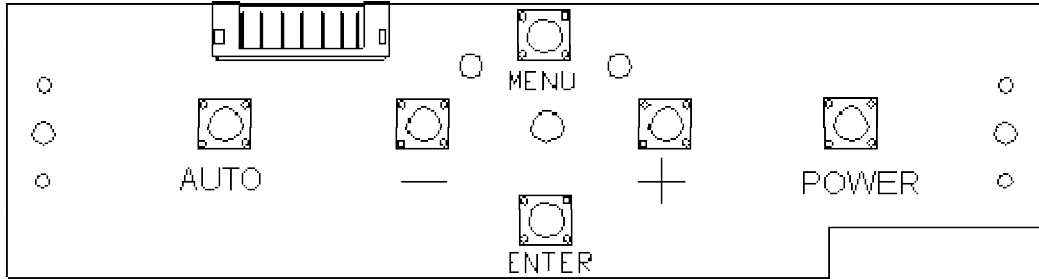

- 
- Power on/off:** Turn on or turn off the monitor.  
**+:** Go to next function/Increase the value.  
**- :** Go back to previous function/Decrease the value.  
**Menu:** Enter the OSD Menu.  
**Enter:** Enter the submenu/Save the value.  
**Auto:** Automatically adjust the screen size to center.

## Hot Key Function

This is a shortcut function to control basic function without accessing the OSD menu.

- +:** For Brightness Control Access  
**- :** For Contrast Control Access

## OSD Menu



### MAIN MENU:

**BRIGHTNESS:** Adjusts background black level of the screen image.

**CONTRAST:** Adjusts foreground white level of the screen image.

**LANGUAGE:** Allows you to choose the OSD menu language from English, French, German, Italian, and Spanish.

**AUDIO CONTROL:** Switching muting ON/OFF and volume control.

**INPUT SELECTION:** Input selection.

**RESET:** Returns all controls back to default settings.

DISPLAY ADJUST	
V-POSITION	050
H-POSITION	080
PITCH	050
PHASE	058
SHARPNESS	000
AUTO BRIGHTNESS	OFF
AUTO TUNING	
RECALL	
RETURN	

**DISPLAY ADJUSTMENT:**

**V. POSITION:** Moves the screen image up or down.

**H. POSITION:** Moves the screen image left or right.

**PITCH:** Adjusts image distortion appearing as vertical bars or “noise” on the screen.

**PHASE:** Adjusts image distortion appearing as horizontal bars or “noise” on the screen.

**SHARPNESS:** Adjusts the clarity and focus of the screen image.

**AUTO TUNING:** Adjusts the picture and screen image to the best condition.

**RECALL:** return all controls back to default settings.

**RETURN:** Back to the previous menu.

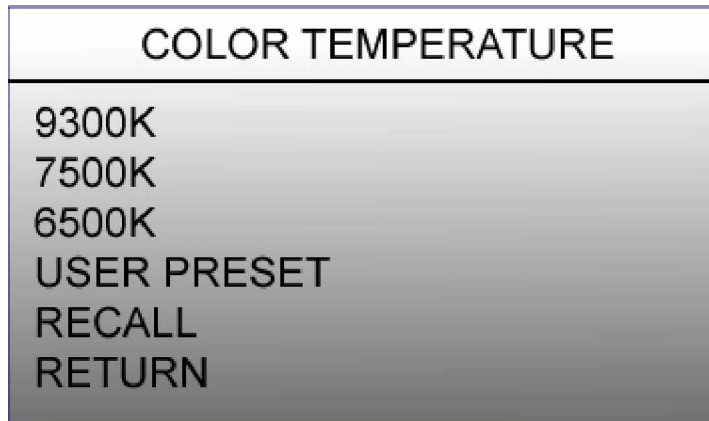

**COLOR TEMPERATURE:**

**9300K:** Cool color

**7500K:** Neutral Color.

**6500K:** Warm Color.

**USER PRESET:** Adjusts the color by user manually.

**RECALL:** return color temperature back to default settings.

**RETURN:** Back to the previous menu.

OSD ADJUST	
OSD H-POS	050
OSD V-POS	050
OSD TIMER	020
OSD TRANSPARENCY	054
TEA TIME	OFF
RECALL	
RETURN	

**OSD ADJUST:**

**OSD H-POS:** Moves the OSD screen image left or right. **OSD**

**V-POS:** Moves the OSD screen image up or down. **OSD**

**TIMER:** Adjust the appearance time for the OSD menu.

**RECALL:** Change the OSD ADJUST settings back to default settings.

**RETURN:** Return to the previous menu.

## Troubleshooting

If you are experiencing trouble with the Open Frame Monitor, refer to the following. If the problem persists, please contact your local dealer.

**Problem: No image appears in the display.**

- Check if the signal cable is firmly seated in the socket.
- Make sure the pin of the connectors are not crooked or broken.
- Check all the I/O and power connectors are installed correctly.

**Problem: Partial image or incorrectly display image.**

- Check to see if the resolution of your computer is higher than that of the LCD display.
- Check all the I/O and power connectors are installed correctly.

**Problem: Position of the screen is not in the center.**

- Adjust the H-position, and V-position, or Perform the Auto adjustment.

**Problem: The screen is too bright (too dark).**

- Check if the brightness or contrast control is at the appropriate position, not at the Maximum/Minimum.

**Problem: The screen is shaking or waving.**

- Press (AUTO) to adjust the best performance.
- Check if the signal timing of the computer system is within the specification of monitor.

## Compatibility Mode

Model	Resolution	H Freq(kHz)	V Freq(kHz)
0	640*480	31.469	59.940
1	640*480	35.000	66.667
2	640*480	37.861	72.809
3	640*480	37.500	75.000
4	720*350	31.469	70.087
5	720*400	31.469	70.087
6	800*600	35.156	56.250
7	800*600	37.879	60.317
8	800*600	48.077	72.188
9	800*600	46.875	75.000
10	832*624	49.750	74.500
11	1024*768	48.363	60.004
12	1024*768	56.476	70.069
13	1024*768	58.038	71.918
14	1024*768	60.023	75.029
15	1280*1024	64.000	60.000
16	1280*1024	80.000	75.000

Any advice or comments about our products and service, or anything we can help you with please don't hesitate to contact with us. We will do our best to support you for your products, projects and business.

**Global American Inc.**

Address: 17 Hampshire Drive  
Hudson, NH 03051

TEL: Toll Free (U.S. Only) 800-833-8999  
(603)886-3900

FAX: (603)886-4545

Website: <http://www.globalamericaninc.com>

E-Mail: [salesinfo@globalamericaninc.com](mailto:salesinfo@globalamericaninc.com)

